



Builder's Best, Inc.  
201 Broiles Drive  
Jacksonville, TX 75766  
903-586-8283  
sales@buildersbest.com  
BuildersBest.com

# Galvanized Roof Vent - Mill Finish GRV620 & GRV624

(Dimensions on reverse)



011756



011772

## DESCRIPTION

The GRV is a heavy duty galvanized Roof Vent hood.

## PRODUCT FEATURES

- Riveted construction, no caulk
- Draw-formed base

## PRODUCT SPECIFICATIONS

- 26 gauge mill finish galvanized steel
- Flapper

## DIMENSIONS

- Dimensions on page 2

## RECOMMENDATION

Recommended for 4/12 roof pitch and steeper.  
Not recommended for flat roofs.

## GRV620

Dia.	Tail	Flapper	Screen	Each #	Qty	Case #	Package	UPC labeled?	UPC
4"	flush	flapper	n/a	12120	1	012120	Ind. Box	•	722048121201
4"	with collar	flapper	n/a	12121	1	012121	Ind. Box	•	722048121218

## GRV624

Dia.	Tail	Flapper	Screen	Each #	Qty	Case #	Package	UPC labeled?	UPC
4"	flush	flapper	¼"x¼" removable	11755	1	011755	Ind. Box	•	722048117556
4"	with collar	flapper	¼"x¼" removable	11756	1	011756	Ind. Box	•	722048117563
6"	flush	flapper	¼"x¼" removable	11793	1	011793	Ind. Box	•	722048117938
6"	with collar	flapper	¼"x¼" removable	11794	1	011794	Ind. Box	•	722048117945
6"-8" (3¼"x10")	flush	flapper	¼"x¼" removable	11772	1	011772	Ind. Box	•	722048117723
7"	flush	flapper	¼"x¼" removable	11773	1	011773	Ind. Box	•	722048117730
7"	with collar	flapper	¼"x¼" removable	11868	1	011868	Ind. Box	•	722048118683
10"	flush	flapper	¼"x¼" removable	11774	1	011774	Ind. Box	•	722048117747

## Labels



## Warranty

Complete Warranty Statement at <https://www.buildersbest.com>



Builder's Best, Inc.  
 201 Broiles Drive  
 Jacksonville, TX 75766  
 903-586-8283  
 sales@buildersbest.com  
 BuildersBest.com

# Galvanized Roof Vent - Mill Finish GRV620 & GRV624

(PNs and Specs on reverse)

## Dimensions (in inches)

Diameter	Collar or Opening:	A	B	C	D	E	F	G	H	I	K	L	collar
4"	flush	4.75	10	11	n/a	3	6	4.75	8.5	6.125	n/a	n/a	n/a
4"	collar	7.25	10	11	2.375	3	6	4.75	8.5	6.125	n/a	n/a	3.375
6"	flush	7	14	14.4375	n/a	4.75	8.5	7	12.25	8.5	n/a	n/a	n/a
6"	collar	9.5	14	14.4375	1.75	4.75	8.5	7	12.25	8.5	n/a	n/a	2.875
7"	flush	7	14	14.4375	n/a	4.75	8.5	7	13.25	11	n/a	n/a	n/a
7"	collar	9.5	14	14.4375	1.75	4.75	8.5	7	13.25	11	n/a	n/a	2.75
*	6"-8" (3¼" x 10")	7	15.675	16	n/a	4.75	11.625	7	15.5	11.5	6.5	10.25	n/a
**	10"	7	15.675	16	n/a	4.75	11.625	7	15.5	11.5	10.75	10.75	n/a

### Collar:

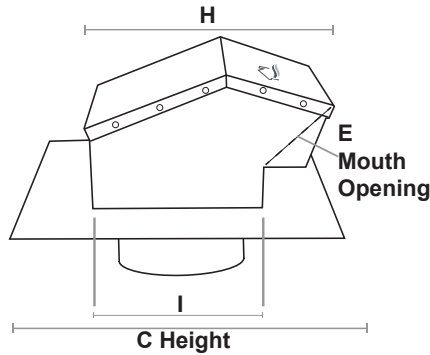
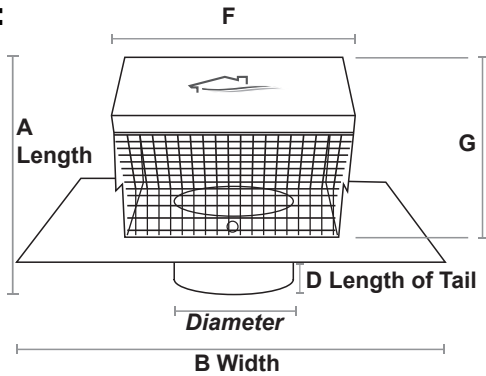

### Flush:

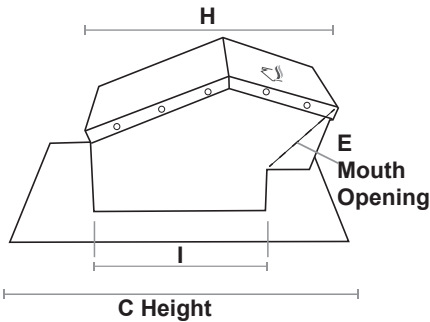
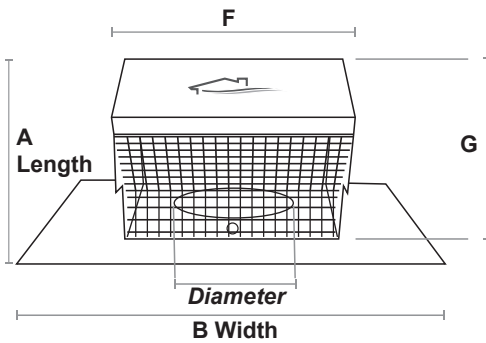

### \* 6"-8" (3¼" x 10") Draw formed base:

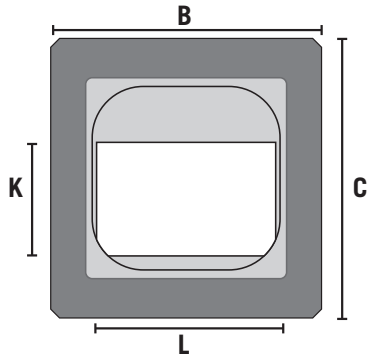

### \*\* 10" Draw formed base:

