

2024 Catalog

July

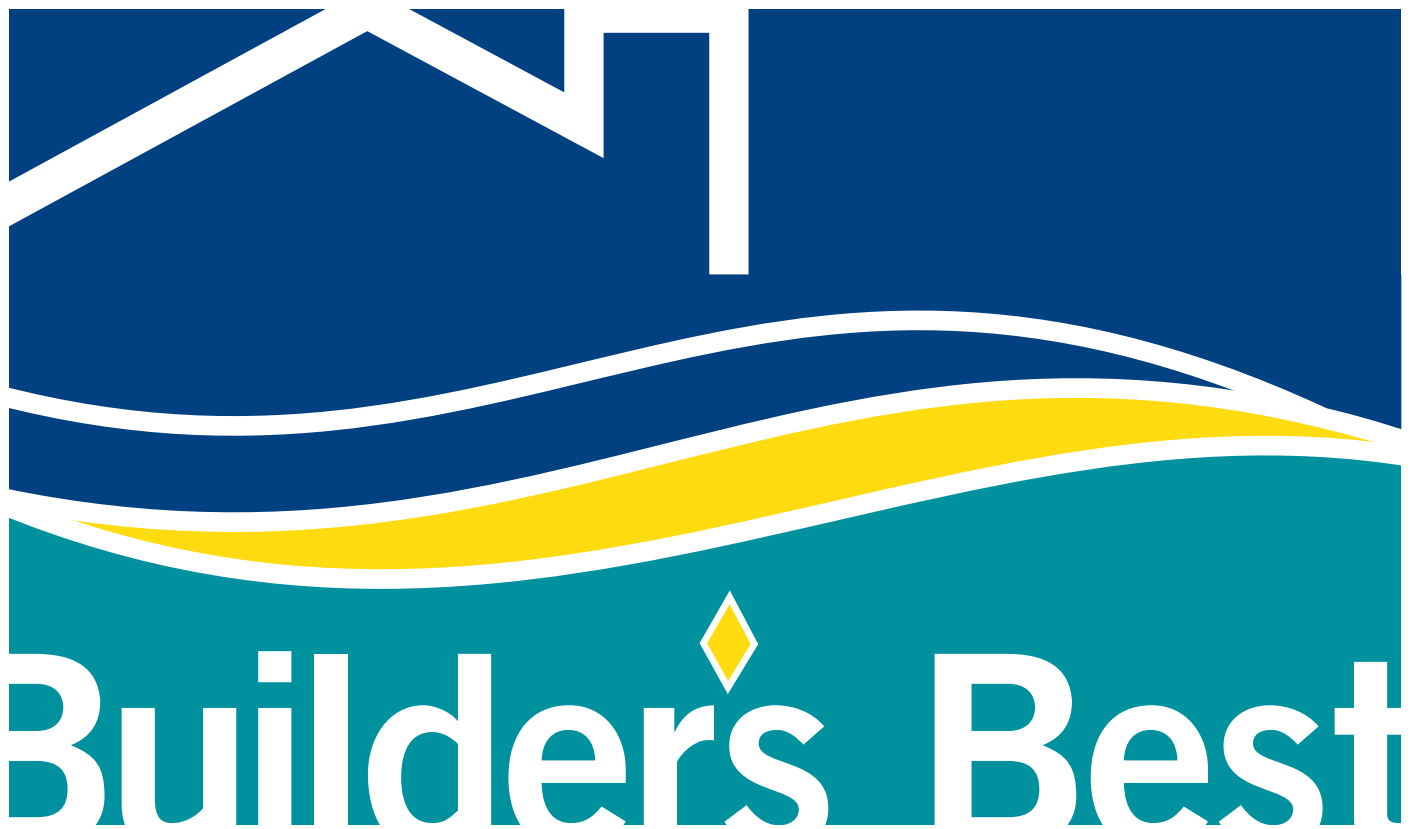

2 Venting Products

3 Semi Rigid

SAF-T-DUCT®
& UL® Dryer
Transition Duct



12 Dryer Vent Kits

Over-The-Top®,
Installers,
Close Loop



23 Wall Vents

Aluminum,
012



4 Semi Rigid

Metalflex® Air Duct



13 Dryer Outlet Box

Reclaim space in
the wall



24 Wall Vents

Aluminum
020



5 Semi Rigid

Thermofin® Air
Duct



14 Foil Hose

Foil, ULTD,
Indoor Lint Traps



26 Wall Vents

P-Tanium™
26 Gauge



6 Semi Rigid

PRO Crimped &
Plain V330, V331,
V230



16 Vinyl Hose

Vinyl, ClearDuct,
Bath Kits



27 Wall Vents

Galvanized
P-Tanium™
30 Gauge

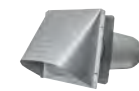

7 Semi Rigid

Crimped & Plain
V320, V321, V220



17 Eave Vents

Aluminum
Builders Best,
Micro Louver



28 Wall Vents

Galvanized
26 Gauge



8 Semi Rigid

A-Seam™ Duct



18 Mini Louver

RDV, EVE, Mini
Louver, SV28,
PEV320, SV



29 Wall Vents

Galvanized
30 Gauge

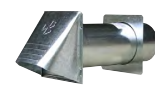

9 Duct Connectors

Extensions,
Couplers



20 Roof Vents

Aluminum



30 Wall Vents

SM, WC,
J Block



9 Rigid Duct

Aluminum &
Galvanized



21 Roof Vents

Galvanized



31 Wall Vents

Plastic
Wide Mouth
Pest Guards



10 Periscopes

0-5, 0-18, 18-29,
29-50, In-wall,
Extensions



22 Roof Vents

Plastic



32 Wall Vents

Plastic
Louvered



11 Elbows

Specialty:
Close Elbow®,
Offset Elbow®



22 Wall Vents

Rectangular



34 Accessories

Foil Tape,
Clamps, Draft
Stopper, Dryer
Heat Diverter



Builder's Best® Snap-Lock™

- Best choice for dryer venting, trusted by professional installers for over 30 years
- 4" Aluminum Snap-Lock™ Fittings make installations easier
- One male (crimped) fitting, one female (slotted) fitting



V850-TD

Dia.	Length	Listing	Each #	Qty	Case #	Package
4"	6'	UL@ 2158A	10548	12	110548	Bulk

V830

Dia.	Length	Listing	Each #	Qty	Case #	Package
4"	6'		10129	12	110129	Display Bag
4"	6'		10005	12	010016	Display Tray
4"	5'		10138	15	110138	Bulk
4"	6'		10107	12	110107	Bulk
4"	8'		10120	20	110120	Bulk
4"	12'		10079	20	110079	Bulk

E-Z-Fasten™

- Excellent choice for dryer venting, trusted by professional installers for over 30 years
- One male (crimped) fitting, one soft-cuff end



V550-TD

Dia.	Length	Listing	Each #	Qty	Case #	Package
4"	8'	UL@ 2158A	10546	12	110546	Bulk

V530

Dia.	Length	Listing	Each #	Qty	Case #	Package
4"	5'		10130	5	110130	Display Bag
4"	5'		10130	15	010150	Display Bag
4"	5'		10105	15	110105	Bulk
4"	8'		10180	20	110180	Bulk
4"	2'		10160	30	110160	Bulk

Readi-Pipe™

- Soft cuff ends are ready to clamp to other components



V450-TD

Dia.	Length	Clamps	Listing	Each #	Qty	Case #	Package
4"	6'		UL@ 2158A	11700	12	111700	Bulk
4"	8'		UL@ 2158A	10545	12	110545	Bulk
4"	8'	2 steel screw	UL@ 2158A	12102	12	112102	Display Bag

V430

Dia.	Length	Clamps	Listing	Each #	Qty	Case #	Package
4"	4'			10088	20	110088	Bulk
4"	5'			10089	15	110089	Bulk
4"	6'			10090	12	110090	Bulk
4"	8'			10091	12	110091	Bulk
4"	8'	2 steel screw		10131	12	110131	Display Bag



V250-TD Plain End

- UL 2158A listed
- Plain ends



Dia.	Length	Listing	Each #	Qty	Case #	Package
4"	8'	UL@ 2158A	10592	12	110592	Bulk

4 Semi-Rigid Flexible Aluminum Air Duct - UL® Labeled

V750 Metalflex® Air Duct

- Universal male/female collar on each end
- 8' pieces compressed to 32"
- UL® 181 label

Dia.	Length	Each #	Qty	Case #	Package
5"	8'	10344	9	110344	Bulk
6"	8'	10345	4	110345	Bulk
7"	8'	10347	4	110347	Bulk
8"	8'	10348	4	110348	Bulk
9"	8'	10350	4	110350	Bulk
10"	8'	10351	4	110351	Bulk
12"	8'	10352	1	010352	Ind. Box
14"	8'	10353	1	010353	Ind. Box
16"	8'	10354	1	010354	Ind. Box
18"	8'	10355	1	010355	Ind. Box
20"	8'	10356	1	010356	Ind. Box
22"	8'	10357	1	010357	Ind. Box
24"	8'	10358	1	010358	Ind. Box

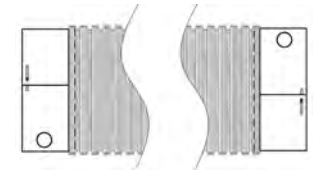

V350-U Metalflex® Air Duct

- One end crimped, one end plain
- Un-compressed 8' length
- UL® 181 label

Dia.	Length	Each #	Qty	Case #	Package	Note
3"	8'	10744	42	110744	Bulk	Regional Availability
4"	8'	10745	25	110745	Bulk	Regional Availability
5"	8'	10759	16	110759	Bulk	Regional Availability
6"	8'	10760	12	110760	Bulk	Regional Availability
7"	8'	10761	9	110761	Bulk	Regional Availability
8"	8'	10762	6	110762	Bulk	Regional Availability
9"	8'	10763	5	110763	Bulk	Regional Availability
10"	8'	10764	4	110764	Bulk	Regional Availability
12"	8'	10755	2	110755	Bulk	Regional Availability

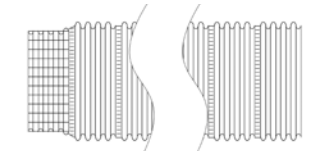

V250 Metalflex® Air Duct

- Plain Ends
- Compressed
- UL® 181 label

Dia.	Length	Each #	Qty	Case #	Package
3"	8'	10803	56	110803	Bulk
3"	10'	10801	40	110801	Bulk
4"	8'	10804	30	110804	Bulk
4"	10'	10802	24	110802	Bulk
5"	8'	10805	15	110805	Bulk
5"	10'	10690	15	110690	Bulk
6"	8'	10806	12	110806	Bulk
6"	10'	10691	12	110691	Bulk
7"	8'	10807	8	110807	Bulk
7"	10'	10692	6	110692	Bulk
8"	8'	10808	6	110808	Bulk
8"	10'	10693	6	110693	Bulk
9"	8'	10809	5	110809	Bulk
10"	8'	10810	4	110810	Bulk

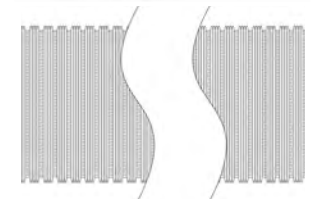

A100-U Thermofin® Air Duct

- Factory crimp on one end
- Uncompressed 8' lengths
- UL® 181 label

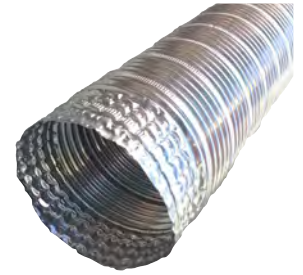

Dia.	Length	Each #	Qty	Case #	Package	Note
3"	8'	11253	42	111253	Bulk	Regional Availability
4"	8'	11254	25	111254	Bulk	Regional Availability
5"	8'	11255	16	111255	Bulk	Regional Availability
6"	8'	11256	12	111256	Bulk	Regional Availability
7"	8'	11257	9	111257	Bulk	Regional Availability
8"	8'	11258	6	111258	Bulk	Regional Availability
9"	8'	11259	5	111259	Bulk	Regional Availability
10"	8'	11260	4	111260	Bulk	Regional Availability
12"	8'	11261	4	111261	Bulk	Regional Availability
14"	8'	11262	4	111262	Bulk	Regional Availability
16"	8'	11263	1	011263	Ind. Box	Regional Availability
18"	8'	11264	1	011264	Ind. Box	Regional Availability
20"	8'	11265	1	011265	Ind. Box	Regional Availability

A300 Insulated Thermofin® Air Duct

- Factory crimp on one end
- Uncompressed 8' lengths
- Insulated - R6
- Outer jacket is silver reinforced "metalized" with scrim mylar vapor barrier.
- UL® 181 label



Dia.	Length	Each #	Qty	Case #	Package	Note
4"	8'	12784	12	112784	Bulk	Regional Availability
6"	8'	12786	6	112786	Bulk	Regional Availability
8"	8'	12788	4	112788	Bulk	Regional Availability
10"	8'	12790	4	112790	Bulk	Regional Availability
12"	8'	12791	3	112791	Bulk	Regional Availability
14"	8'	12792	2	112792	Bulk	Regional Availability
16"	8'	12793	1	012793	Ind. Box	Regional Availability
18"	8'	12794	1	012794	Ind. Box	Regional Availability

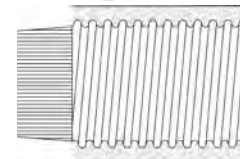

Semi-Rigid Flexible Aluminum Duct - Non-Labeled

V730 Double Female Ends

- Aluminum universal female collars overlap for smooth seams

Dia.	Length	Clamps	Each #	Qty	Case #	Package
3"	8'	n/a	10300	20	011454	Bulk
4"	8'	n/a	10304	12	011456	Bulk
3"	8'	2 steel screw	10303	20	011501	Bulk
4"	8'	2 steel screw	10307	12	011502	Bulk

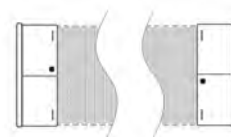

V620 Push Fit™

- Aluminum collars overlap for smooth seams

Dia.	Length	Each #	Qty	Case #	Package
4"	2'	11564	12	111564	Bulk
4"	2'	11564	288	611564	Skid
4"	4'	10550	15	110550	Bulk
4"	8'	10551	12	110551	Bulk



6 Semi-Rigid Flexible Aluminum Duct - Non-Labeled

V330 PRO

One crimped end and one plain end



Dia.	Length	Each #	Qty	Case #	Package
3"	8'	10308	20	011489	Bulk
3"	8'	11637	10	111637	Display Tag
4"	8'	10312	12	011491	Bulk
4"	8'	11638	12	111638	Display Tag
5"	8'	10316	6	011493	Bulk
6"	8'	10317	4	110317	Bulk
6"	8'	11640	4	111640	Display Tag
7"	8'	10319	4	110319	Bulk
8"	8'	10320	4	110320	Bulk
8"	8'	11699	4	111699	Display Tag
9"	8'	10322	4	110322	Bulk
10"	8'	10323	4	110323	Bulk
10"	8'	11702	4	111702	Display Tag
12"	8'	10246	4	110246	Bulk
14"	8'	11393	2	111393	Bulk

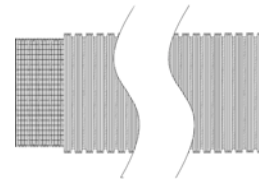

V331 PRO

Same as V330 but with a double crimp on one end



Dia.	Length	Each	Qty	Case #	Package
3"	8'	10581	20	011450	Bulk
3"	8'	10581	400	710581	Skid
4"	8'	10582	12	011452	Bulk
4"	8'	10582	240	710582	Skid

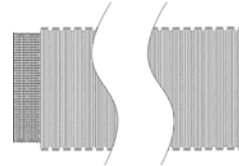

V230 PRO

Same as V330 above but with plain ends



Dia.	Length	Clamps	Each #	Qty	Case #	Package
3"	8'		10250	20	110250	Bulk
3"	10'		10251	20	110251	Bulk
3"	20'		10401	25	110401	Bulk
3"	25'		10252	25	110252	Bulk
4"	8'		10087	12	110087	Bulk
4"	10'		10253	12	110253	Bulk
4"	10'		10253	240	710253	Skid
4"	20'		10402	16	110402	Bulk
4"	25'		10315	16	110315	Bulk
5"	8'		10255	6	011476	Bulk
5"	10'		10256	9	110256	Bulk
5"	20'		10257	9	110257	Bulk
6"	8'		10258	4	011479	Bulk
6"	8'		10258	72	710258	Skid
6"	10'		10259	12	110259	Bulk
6"	20'		10260	6	110260	Bulk
7"	8'		10261	4	011482	Bulk
7"	10'		10262	8	110262	Bulk
7"	20'		10263	4	110263	Bulk
8"	8'		10264	4	110264	Bulk
8"	10'		10265	6	011487	Bulk
8"	20'		10266	4	110266	Bulk
9"	8'		10267	4	110267	Bulk
9"	10'		10268	4	110268	Bulk
9"	20'		10269	4	110269	Bulk
10"	8'		10383	4	110383	Bulk
10"	10'		10384	4	110384	Bulk
10"	20'		10385	4	110385	Bulk
12"	8'		10247	4	110247	Bulk
14"	8'		10248	2	110248	Bulk
4"	8'	2 steel screw	10460	12	110460	Display Bag

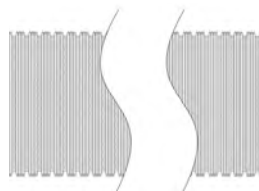

Thicker Walls

V320

One crimped end and one plain end (lighter version of V330)

Dia.	Length	Each #	Qty	Case #	Package
3"	8'	10443	10	110443	Display Bag
3"	8'	10433	20	011458	Bulk
4"	8'	10444	12	110444	Display Bag
4"	8'	10434	12	110434	Bulk
4"	20'	10439	16	110439	Bulk
5"	8'	10445	6	110445	Display Bag
5"	8'	10435	6	110435	Bulk
6"	8'	10446	4	011463	Display Bag
6"	8'	10436	4	010431	Bulk
7"	8'	10447	4	011465	Display Bag
7"	8'	10437	4	011466	Bulk
8"	8'	10448	4	011468	Display Bag
8"	8'	10438	4	011469	Bulk

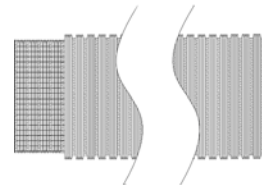

V321

Same as V320 above but with a double crimp on one end (lighter version of V331)

Dia.	Length	Each #	Qty	Case #	Package
3"	8'	10583	20	011471	Bulk
4"	8'	10584	12	110584	Bulk
5"	8'	10585	6	110585	Bulk
6"	8'	10586	4	011473	Bulk
7"	8'	10587	4	011474	Bulk
8"	8'	10588	4	011475	Bulk

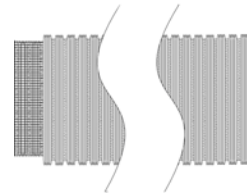

V220

Same as V320 above but with Plain Ends (lighter version of V320)

Dia.	Length	Clamps	Each #	Qty	Case #	Package
3"	8'		10453	10	110453	Display Bag
3"	8'		11583	10	111583	Display Tag
3"	8'		10403	20	011436	Bulk
3"	20'		10420	25	110420	Bulk
3"	25'		10421	25	110421	Bulk
4"	5'		10400	15	110400	Bulk
4"	8'		10454	12	110454	Display Bag
4"	8'		11584	12	111584	Display Tag
4"	8'		10404	12	110404	Bulk
4"	20'		10429	16	110429	Bulk
4"	25'		10419	16	110419	Bulk
5"	8'		11585	6	111585	Display Tag
5"	8'		10405	6	110405	Bulk
5"	10'		10415	9	011440	Bulk
5"	20'		10425	9	110425	Bulk
6"	8'		11586	4	111586	Display Tag
6"	8'		10406	4	011441	Bulk
6"	10'		10416	12	110416	Bulk
6"	10'		10822	12	110822	Display Tag
6"	20'		10426	6	011443	Bulk
7"	8'		11587	4	111587	Display Tag
7"	8'		10407	4	011444	Bulk
7"	10'		10417	8	110417	Bulk
7"	10'		10823	8	110823	Display Tag
8"	8'		11588	4	111588	Display Tag
8"	8'		10408	4	011447	Bulk
8"	10'		10418	6	110418	Bulk
8"	10'		10824	6	110824	Display Tag
4"	8'	2 steel screw	10459	12	110459	Display Bag

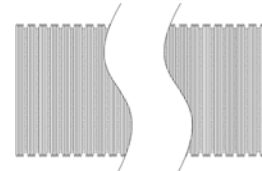

Thinner Walls

8 Semi-Rigid Flexible Aluminum Duct - Non-Labeled

A250-TD Plain End A-Seam™

- UL 2158A listed
- Plain ends
- Unique, patented compression takes less space



Dia.	Length	Listing	Each #	Qty	Case #	Package
4"	8'	UL® 2158A	12103	12	112103	Display Bag

A100 A-Seam Stretch-Fit™ Thermofin® Air Duct

- Factory crimp on one end
- Unique, patented compression takes less space
- UL® 181 label



Dia	Length	Each #	Qty	Case #	Package	Note
3"	8'	12820	20	112820	Bulk	Regional Availability
4"	8'	12821	12	112821	Bulk	Regional Availability
5"	8'	12822	7	112822	Bulk	Regional Availability
6"	8'	12823	4	112823	Bulk	Regional Availability
7"	8'	12824	3	112824	Bulk	Regional Availability
8"	8'	12825	4	112825	Bulk	Regional Availability
10"	8'	12827	2	112827	Bulk	Regional Availability
12"	8'	12828	1	012828	Bulk	Regional Availability

A220 A-Seam™

- Class 0 duct for general use
- Plain Ends
- Unique, patented compression takes less space

Dia.	Length	Each	Qty	Case #	Package
3"	10'	12903	20	112903	Bulk
3"	10'	12903	400	712903	Skid
4"	10'	12911	12	112911	Bulk
4"	10'	12911	240	712911	Skid



**A-Seam
Patented
compression
takes
less space**

SAF-T-DUCT® Aluminum Extension Collar

- 4" Dia. x 3" long aluminum collar with snap-lock fittings
- Designed to extend the reach of Snap-Lock™ collars
- Can be used with Close Elbow®, Offset Elbows and periscope collars



Dia.	Length	Description	Each #	Qty	Case #	Package
4"	3.25"	one end crimped, one end slotted	10103	25	110103	Bulk

Aluminum Duct Collar/Coupler

- Aluminum coupling to connect pieces of pipe
- Crimped & hemmed end on 10490, 10491 and 11536 is designed to help prevent duct from sliding off



10137



10490,
10491 & 11536

Dia.	Length	Description	Each #	Qty	Case #	Package	UPC
3"	3"	both ends crimped & hemmed	10490	12	110490	Bulk	•
4"	3"	both ends crimped & hemmed	10491	12	110491	Bulk	•
6"	3"	both ends crimped & hemmed	11536	6	111536	Bulk	•
4"	2.25"	one end crimped, one end beaded	10137	25	110137	Bulk	

Galvanized Duct Collar/Coupler

- Galvanized coupling
- Connect pieces of pipe, hemmed ends help prevent duct from sliding off

Dia.	Length	Description	Each #	Qty	Case #	Package
3"	4"	both ends crimped	11689	16	111689	Bulk
4"	4"	both ends crimped	11690	9	111690	Bulk
6"	4"	both ends crimped	11691	4	111691	Bulk



Increaser & Reducer

- Connect ducts of different diameters

Dia.	Description	Each #	Qty	Case #	Package	UPC
3-4"	Aluminum increaser 3" to 4"	10493	12	110493	Bulk	•
4-3"	Aluminum reducer 4" to 3"	10492	12	110492	Bulk	•
3-4"	Plastic increaser/reducer 3" to 4"	10290	10	110290	Bulk	•



10493



10492



10290

Rigid Duct - Round

Rigid Pipe

- One crimped end and one plain end
- Galvanized, V040 Heavy aluminum, V020 mid-weight aluminum
- Ships nested, secure on-site with Reeves-Lock snap-together assembly
- Model V040 .016 Aluminum meets most building codes for in-wall applications

Dia.	Length	Description	Material	Each #	Qty	Case #	Package	UPC
4"	2'	Rigid Pipe	30 gauge Galvanized	10182	25	110182	Bulk	
4"	5'	Rigid Pipe	30 gauge Galvanized	11002	15	111002	Bulk	
4"	2'	V040	.016 Aluminum	10642	25	110642	Bulk	•
4"	5'	V040	.016 Aluminum	10643	15	110643	Bulk	•
4"	2'	V020	.010 Aluminum	10638	25	110638	Bulk	•
4"	5'	V020	.010 Aluminum	10639	15	110639	Bulk	•



10 Rigid Duct - Periscopes

- 2" x 6" rigid aluminum
- One male crimped fitting
- One draw-band collar for dryer connection
- telescopes to lengths below

Zero Periscope™

- Available in 0-5 and 0-18 lengths
- Use where outlets overlap or are very close
- Baffles help direct airflow in 3-5" situations
- Sections are not reversible

18-29" Periscope

- Reaches side of most dryers
- Two piece assembly
- Sections are reversible for airflow the same or opposite

29-50" Periscope

- Reaches top of most dryers
- Four piece assembly
- Sections are reversible for airflow the same or opposite

Extension pieces

- 2" x 6" rigid metal with no fittings
- Slide into and over 18-29, 29-50 and 29-72" sections to lengthen.
- Use aluminum tape to secure the sections

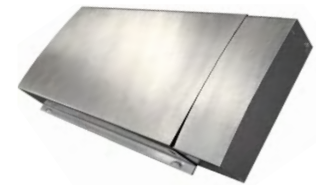
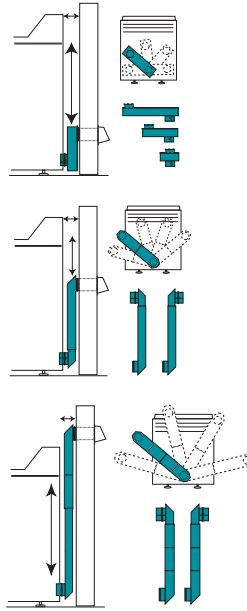

Dia.	Length	Note	Each #	Qty	Case #	Package
4"	0-5"	with baffle	10175	9	110175	Display Card
4"	0-5"	no baffle	10144	9	110144	Bulk
4"	0-5"	no baffle	10149	9	110149	Ind. Box
4"	0-18"	with baffle	10172	4	110172	Display Box
4"	0-18"	with baffle	10128	4	110128	Display Bag
4"	0-18"	with baffle	10128	8	010158	Display Bag
4"	0-18"	with baffle	10146	8	110146	Bulk
4"	0-18"	with baffle	10148	4	110148	Ind. Box
4"	0-18"	UL® with baffle	12276	4	112276	Ind. Box
4"	18-29"		10173	4	110173	Display Box
4"	18-29"		10133	4	110133	Display Bag
4"	18-29"		10133	9	010153	Display Bag
4"	18-29"		10114	9	110114	Bulk
4"	18-29"		10116	4	110116	Ind. Box
4"	18-29"	UL@2158A	12277	4	112277	Ind. Box
4"	29-50"		10174	4	110174	Display Box
4"	29-50"		10117	4	110117	Ind. Box
n/a	23"	extension	10141	8	110141	Bulk
n/a	43"	extension	10142	8	110142	Bulk

Periscopes:

- 2" x 6" rigid aluminum
- Telescoping
- Close clearance

In-Wall Periscope / Rough-In Systems

- Four telescoping sections
- Standard 4" diameter fittings, one male snap-lock and one female snap-lock
- Mounting strap included



Dia.	Length	Material	Each #	Qty	Case #	Package
4"	29"-72"	30 ga. Galvanized	10868	3	110868	Ind. Box
4"	52"-95"	30 ga. Galvanized	10869	3	110869	Ind. Box
4"	29"-72"	Aluminum	10094	3	110094	Display Box
4"	29"-72"	Aluminum	10140	3	110140	Ind. Box

Close Elbow®

- Aluminum 90° elbow turns 90° within 4"
- Best choice for 90° turns, especially on the dryer
- Rotating snap-lock collars connect without clamps to other snap-lock collars



Dia.	Note	Collar 1	Collar 2	Each #	Qty	Case #	Package
4"		male (crimped)	female (slotted)	10161	6	110161	Display Card
4"		male (crimped)	female (slotted)	10161	24	010151	Display Card
4"	1 clamp	male (crimped)	female (slotted)	10108	24	110108	Bulk
4"	UL® 2158A w/ clamp	male (crimped)	female (slotted)	12270	24	112270	Bulk

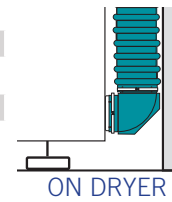

Wall Offset Elbow®

- Aluminum 90° elbow turns 90° within 4"
- Snap-lock collars connect without clamps to other snap-lock collars
- Use when outlet pipe in wall protrudes up to 2.5" and cannot be trimmed



Dia.	Collar 1	Collar 2	Each #	Qty	Case #	Package
4"	male rotates	female (slotted)	10162	4	110162	Display Card
4"	male rotates	female (slotted)	10162	20	010152	Display Card
4"	male rotates	female (slotted)	10109	20	110109	Bulk

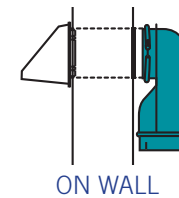

Dryer Offset Elbow®

- Aluminum 90° elbow turns 90° within 4"
- Snap-lock collars connect without clamps to other snap-lock collars
- Use when outlet pipe on dryer protrudes up to 2.5" and cannot be trimmed
- Can also be used on wall outlet pipe if pipe is too large for Wall Offset Elbow



Dia.	Collar 1	Collar 2	Each #	Qty	Case #	Package
4"	male (crimped)	female rotates	10165	4	110165	Display Card
4"	male (crimped)	female rotates	10165	20	010155	Display Card
4"	male (crimped)	female rotates	10110	20	110110	Bulk

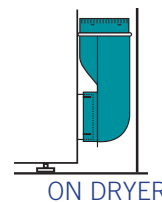

Adjustable Elbow

- One crimped end and one plain end
- 4-piece sectional adjustability
- Long Sweep Elbow measures the same as straight pipe to help overcome length of run issues

Dia.	Description	Material	Each #	Qty	Case #	Package	UPC
4"	Adjustable Elbow	30 gauge Galvanized	10181	12	110181	Bulk	
4"	Adjustable Elbow	30 gauge Galvanized	10181	660	710181	Skid (55 cases)	
6"	Adjustable Elbow	30 gauge Galvanized	12339	6	112339	Bulk	
4"	Adjustable Elbow	.014 Aluminum (lighter)	10544	12	110544	Bulk	•
4"	Adjustable Elbow	.016 Aluminum (heavier)	12422	12	112422	Bulk	•
4"	Adjustable Elbow	.016 Aluminum (heavier)	12422	660	712422	Skid (55 cases)	•
4"	Long Sweep Elbow	30 gauge Galvanized	11645	12	111645	Bulk	
4"	Long Sweep Elbow	Aluminum (lighter)	11646	12	111646	Bulk	



GALVANIZED ELBOW



ALUMINUM ELBOW



LONG SWEEP ELBOW

12 Dryer Vent Kits

OTT Over-The-Top® Dryer Vent Kit

- Installs in 4½", when wall pipe is trimmed flush and wall plate is used. Swivel collars on elbows allow dryer to be pulled away from wall for cleaning without disconnecting. Semi-rigid flexible duct snap-locks together, as final step.

Kit contains:

- Two - 4 ft duct sections attached to two Close Elbows®
- Two - steel screw clamps for wall and dryer connections
- One - wall plate for flush clearance

Dia.	Length	Elbows	Clamps	Each #	Qty	Case #	Package
4"	8'	2 Close Elbows®	2 steel screw	10171	4	110171	Display Box
4"	8'	2 Close Elbows®	2 steel screw	10127	6	110127	Bulk

UL® TD (Transition Duct) Listed 2158A version:

4"	8'	2 Close Elbows®	2 steel screw	11920	4	111920	Ind. Box
----	----	-----------------	---------------	-------	---	--------	----------



OVER-THE-TOP®

INST Installer's Kit™ Dryer Vent Kit

Wall offset elbow allows the wall pipe to protrude up to 2½" without trimming.

Kit contains:

- One - 4 ft duct section attached to a Close Elbow®
- One - 4 ft duct section attached to a Wall Offset Elbow®
- One - extension collar (for recessed wall pipe)
- Two - steel screw clamps for wall and dryer connection

Dia.	Length	Elbows	Clamps	Each #	Qty	Case #	Package
4"	8'	1 Close, 1 Wall	2 steel screw	10095	4	110095	Ind. Box
4"	8'	1 Close, 1 Wall	2 steel screw	10096	6	110096	Bulk

UL® TD (Transition Duct) 2158A version:

4"	8'	1 Close, 1 Wall	2 steel screw	11922	4	111922	Ind. Box
----	----	-----------------	---------------	-------	---	--------	----------



INSTALLER'S KIT

CLOS-TD Close Loop™ UL® Listed Dryer Vent Kit

UL® Transition Duct 2158A Listed Kit contains:

- 1 - 6 ft UL® semi-rigid flexible duct
- 2 - Close Elbows®
- 2 - steel screw clamps for wall and dryer connection

Dia.	Length	Elbows	Clamps	Each #	Qty	Case #	Package
4"	6'	2 Close Elbows®	2 steel screw	11693	4	111693	Ind. Box
4"	6'	2 Close Elbows®	2 steel screw	11926	4	111926	Display Box



6' CLOSE LOOP KIT

SEK-TD Single Elbow UL® Listed Dryer Vent Kit

UL® Transition Duct 2158A Listed Kit contains:

- 1 - 8 ft UL® semi-rigid flexible duct
- 1 - Close Elbow®
- 2 - steel screw clamps for wall and dryer connection

Dia.	Length	Elbows	Clamps	Each #	Qty	Case #	Package
4"	8'	1 Close Elbows®	2 steel screw	12423	4	112423	Ind. Box



SINGLE ELBOW KIT

EVK Elbow Vent Kit - All Metal Dryer Vent Kits



10049

Dia.	Length	Duct	Elbows	Clamps	Each #	Qty	Case #	Package
4"	6'	V830 Builder's Best	2 Close Elbows	2 steel	10043	4	110043	Ind. Box
4"	6'	V430 Readi-Pipe	2 Close Elbows	4 steel	10049	4	110049	Ind. Box
4"	8'	V430 Readi-Pipe	2 Close Elbows	4 steel	10050	4	110050	Ind. Box

WHK Wall Hood Kit - Aluminum Dryer Vent Kits

Hoods have 10" tails and may require assembly



10537

Dia.	Length	Duct	Hood	Color	Clamps	Each #	Qty	Case #	Package
4"	5'	V230 Plain	AWM320 aluminum wide mouth	silver	2 steel	12101	4	112101	Ind. Box
4"	8'	V230 Plain	AWM320 aluminum wide mouth	silver	2 steel	10536	4	110536	Bulk
4"	8'	V220 Plain	PWM620 plastic wide mouth	white	2 steel	10625	12	110625	Ind. Box
4"	8'	V220 Plain	PWM620 plastic wide mouth	brown	2 steel	10626	12	110626	Ind. Box
4"	8'	V220 Plain	PML320 plastic multi louver	brown	2 steel	12100	6	112100	Ind. Box
4"	8'	V220 Plain	PML320 plastic multi louver	white	2 steel	11405	6	111405	Display Box
4"	5'	V220 Plain	AWM320 aluminum wide mouth	silver	2 steel	10537	4	110537	Display Box

Dryer Outlet Box

Dryer Outlet Box - Plastic



This dryer outlet box cleanly finishes off dryer vent rough-ins and recaptures space in the wall behind the dryer for venting.

- One Self trimming unit: 18" wide by 24" high
- Fits all 16" centers 2x4's and 2x6's;
- Six patented rip-tab knockouts in most common positions
 - Four true 4" Dia. knockouts (two rear, two right upper and lower)
 - Two 3" x 4.5" oval knockouts (left upper and lower)

Oval knockouts are provided for non-standard connections to existing venting (i.e. squashed duct), or for a round to oval adapter.

- Four starburst knockouts for gas connections and venting
- Six pre-drilled mounting holes
- Plastic meets UL® standard 94 HB tests for flammability
- Six screws included

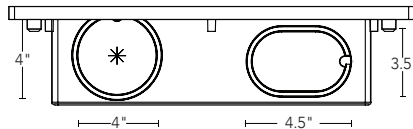

Dryer Outlet Box Kit

Kit Includes:

- One DOB-P Dryer Outlet Box
- One Aluminum Periscope (2 extensions for 8' and 3 extensions for 10')
- Two rectangle to round transitions 10518

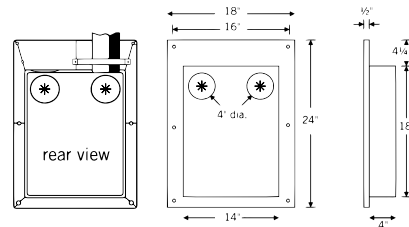

WITH 11396 ADAPTER



DRYER OUTLET BOX KIT



10518

11396

Description	Accessories	Each #	Qty	Case #	Package
Single Box	n/a	10697	10	110697	Bulk
Single Box	n/a	10698	3	110698	Ind. Box
Single Box	n/a	10696	3	110696	Display Box
Single Box	one round to oval adapter	11563	3	111563	Display Box
Kit for 8' Wall	box, periscope, 2 transitions	11000	5	111000	Ind. Box
Kit for 10' wall	box, periscope, 2 transitions	11001	5	111001	Ind. Box
Adapter	aluminum rectangle to round	10518	12	110518	Bulk
Adapter	aluminum round to oval	11396	16	111396	Bulk

14 Wire Helix Aluminum/Poly Foil Hose

WMF621 Wire helix Multi-ply Foil Duct

- Wire helix duct with steel wire support
- Multi-ply design of aluminum/polyester laminate and metalized polyester
- PRO Performance Level
- UL® 181, Class 1 air connector label; UL® sticker every 10 feet
- 3" dia. has ¾" pitch; 4–12" dia. has 1" pitch
- Maximum velocity rating 5000 fpm



Dia.	Length	Clamps	Each #	Qty	Case #	Package	Special Order
3"	8'		10218	12	110218	Bulk	Special Order
3"	25'		10201	4	110201	Bulk	
3"	25'		10825	16	110825	bag	
3"	25'		10221	5	110221	Ind. Box	
3"	50'		10215	4	110215	Ind. Box	
4"	5'		10219	12	110219	Bulk	
4"	5'		10223	12	110223	Display Box	
4"	8'		10224	12	110224	Display Box	
4"	8'		10220	12	110220	Bulk	
4"	8'		10220	36	010242	Bulk	
4"	25'		10202	4	110202	Bulk	
4"	25'		10826	16	110826	Bag	
4"	25'		10222	5	110222	Ind. Box	
4"	50'		10216	4	110216	Ind. Box	
4"	50'		10244	4	110244	Display Box	
5"	25'		10203	1	010203	Ind. Box	
6"	25'		10204	1	010204	Ind. Box	
7"	25'		10205	1	010205	Ind. Box	Special Order
8"	25'		10206	1	010206	Ind. Box	Special Order
9"	25'		10207	1	010207	Ind. Box	Special Order
10"	25'		10208	1	010208	Ind. Box	Special Order
12"	25'		10210	1	010210	Ind. Box	Special Order
4"	8'	2 spring	10680	12	110680	Bag	
4"	5'	2 steel screw	10660	12	110660	Display Bag	
4"	8'	2 steel screw	10661	12	110661	Display Bag	

Foil Duct:
 • UL® 181
 rating for
 HVAC general
 purposes

WHK Wall Hood Kit - Foil Bath Fan Vent Kit

- UL® 181 Foil Duct WMF621
- Hood (see below)
- Zip Torq™ Clamps



10533

Dia.	Length	Hood	Color	Clamps	Each #	Qty	Case #	Package
4"	5'	PWM620 plastic wide mouth	white	2 Zip Torq™	10620	4	110620	Ind. Box
4"	8'	PWM620 plastic wide mouth	white	2 Zip Torq™	10618	4	110618	Ind. Box
4"	8'	ASM320 aluminum standard mouth	silver	2 Zip Torq™	10533	4	110533	Ind. Box
4"	5'	ASM320 aluminum standard mouth	silver	2 Zip Torq™	10603	4	110603	Ind. Box
4"	5'	PML320 plastic multi louver	brown	2 Zip Torq™	10611	4	110611	Ind. Box
4"	5'	PML320 plastic multi louver	white	2 Zip Torq™	10612	4	110612	Ind. Box
4"	8'	PML320 plastic multi louver	brown	2 Zip Torq™	10609	4	110609	Ind. Box
4"	8'	PML320 plastic multi louver	white	2 Zip Torq™	10610	4	110610	Ind. Box
4"	8'	PML320 plst multi louver & Incr/Red	white	2 Zip Torq™	11520	6	111520	Display Box



11520

RVK Roof Vent Kit - Foil Dryer and Bath Fan Vent

- UL® 181 Foil Duct WMF621
- Roof Cap (see below)
- Plastic Increaser/Reducer included with Roof Cap Kits



12640 ROOF VENT KIT

Dia.	Length	Hood - Material	Clamps	Each #	Qty	Case #	Package
4"	8'	GRV824 Black Galvanized Roof Cap	2 Zip Torq™	12640	1	012640	Ind. Box

WMF661 Wire helix Multi-ply Foil SilverDuct™

- Wire helix duct steel wire support
- Multi-ply design of aluminum/polyester laminate and metalized polyester
- PRO performance level
- UL® 2158A listed and labeled as foil dryer transition duct
- This product is not recommended by Builder's Best as dryer venting
- Check your clothes dryer manufacturer manual as installation may invalidate warranties
- Check local building codes for appropriate use



Dia.	Length	Clamps	Each #	Qty	Case #	Package
4"	5'		10504	12	110504	Bulk
4"	5'		10504	72	010507	Bulk
4"	5'		10676	6	110676	Display Box
4"	8'		10505	12	110505	Bulk
4"	8'		10505	54	010508	Bulk
4"	8'		10677	6	110677	Display Box
4"	8'		10677	20	010793	Display Box
4"	5'	2 spring	10670	12	110670	bag
4"	8'	2 spring	10671	12	110671	bag
4"	5'	2 ZipTorq™	10672	12	110672	Display Box
4"	8'	2 ZipTorq™	10673	12	110673	Display Box

WMF651 Wire helix Multi-ply Foil SilverDuct™

- Meets UL® 2158A standard
- NOT labeled *Long lengths are constructed to meet UL® 2158A. However, there is no UL® label since clothes dryer transition duct venting is only allowed to be 8 feet in length.*

Dia.	Length	Clamps	Each #	Qty	Case #	Package
4"	20'		11506	6	111506	Display Box
4"	25'		11504	5	111504	Ind. Box
4"	50'		11505	4	111505	Ind. Box



WHK Wall Hood Kit - SilverDuct™ Dryer Vent Kit

- UL® 2158A Dryer Foil Duct WMF661
- Hood (see below)
- Zip Torq™ Clamps



Dia.	Length	Hood	Clamps	Each #	Qty	Case #	Package
4"	5'	PML320 plastic multi louver white	2 ZipTorq™	11406	6	111406	Display Box
4"	8'	PML320 plastic multi louver white	2 ZipTorq™	11407	6	111407	Display Box
4"	8'	PWM622 plastic wide mouth bird guard white	2 ZipTorq™	11408	8	111408	Display Box
4"	8'	PWM622 plastic wide mouth bird guard brown	2 ZipTorq™	11528	8	111528	Display Box

11408

Lint Trap

- Plastic canister with twist lock separates for filling and cleanup.
- Catches lint from clothes dryer in bucket (Bucket is filled with water at each load.)
- For temporary use only.
- Not for gas dryers
- **Warnings:**
*It must be cleaned promptly after each load.
Check manuals as this product may invalidate warranties.
Check local building codes for appropriate use.*



10597



Dia.	Length	Description	Clamps	Each #	Qty	Case #	Package
4"		Indoor Lint Trap bucket only		10496	48	110496	Bulk
4"		Indoor Lint Trap bucket only		10646	9	110646	Display Box
4"	5'	Indoor Lint Trap Kit, SilverDuct™ WMF661	2 spring	10597	9	110597	Display Box
4"	5'	Indoor Lint Trap Kit, V220 Duct	2 steel	10497	3	110497	Ind. Box

16 Wire Helix Poly Vinyl Hose

WPV601 Wire helix Poly/Plastic Vinyl Duct - PRO

- Thickest version of Poly Vinyl Chloride material
- Wire helix duct with steel wire support with 1" pitch

Useful as bathroom fan venting. Not approved for dryer venting.

Dia.	Length	Clamps	Each #	Qty	Case #	Package
3"	5'		10046	12	110046	Bulk
3"	8'		11534	12	111534	Display Label
3"	8'		10047	12	110047	Bulk
3"	20'		10048	5	110048	Ind. Box
3"	50'		10053	4	110053	Ind. Box
4"	5'		10111	12	110111	Bulk
4"	8'		10052	12	110052	Display Label
4"	8'		10112	12	110112	Bulk
4"	20'		10059	5	110059	Ind. Box
4"	50'		10062	4	110062	Ind. Box
4"	8'	2 Zip Torq™	10653	12	110653	Display Bag



WHK Wall Hood Kit - Vinyl Bath Vent Kits

- WPV601 PRO Vinyl (see above) with Hood and two clamps

Dia.	Length	Hood	Clamps	Each #	Qty	Case #	Package
4"	8'	AWM320 aluminum wide mouth	2 ZipTorq™	11522	8	111522	Display Box
4"	8'	PML320 plastic multi louver brown	2 ZipTorq™	11510	6	111510	Display Box
4"	8'	PML320 plastic multi louver white	2 ZipTorq™	11511	6	111511	Display Box
4"	8'	PWM624 plastic wide mouth bird guard white	2 ZipTorq™	11517	8	111517	Display Box



11511
VINYL BATH KIT WITH
LOUVERED HOOD



11517



11522

WPV401 Wire helix Poly/Plastic Vinyl Duct - Standard

- Lightweight version of Poly Vinyl Chloride material
- Wire helix duct with steel wire support: 3¼" and 3" Dia. are 1" pitch; 4" Dia. is 1½" pitch
- * Useful as bathroom fan venting * Not approved for dryer venting.

Dia.	Length	Each #	Qty	Case #	Package
3"	5'	10562	12	110562	Bulk
3"	8'	10563	12	110563	Bulk
3"	20'	10564	5	110564	Ind. Box
3"	50'	10565	4	110565	Ind. Box
3"	50'	10565	120	610565	Skid/Ind. Box
3¼"	20'	10054	28	110054	Bulk
3¼"	50'	10055	4	110055	Ind. Box
4"	5'	10566	12	110566	Bulk
4"	8'	10567	12	110567	Bulk
4"	8'	10567	72	010559	Bulk
4"	20'	10568	5	110568	Ind. Box
4"	50'	10569	4	110569	Ind. Box
4"	50'	10569	160	610569	Skid/Ind. Box



WPC601 Wire helix Poly/Plastic ClearDuct™

- Thick Poly Vinyl Chloride material with steel wire support and 1" pitch
- Useful as bathroom fan venting. Not approved for dryer venting.

Dia.	Length	Clamps	Each #	Qty	Case #	Package
4"	8'	2 Zip Torq™	00017	12	100017	Display Box
4"	25'		10487	9	110487	Bulk
4"	50'		10509	4	110509	Ind. Box

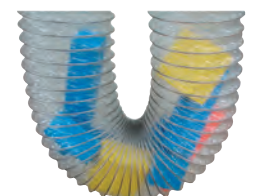

DUCT IS CLEAR
(BLOCKS NOT INCLUDED)

AEV Aluminum Eave Vent Builder's Best Eave Vent

- Aluminum construction, fits flush into eave
- 110189 Intake does not have flapper, meeting IBC codes.
- Dryer vents should not be screened, per IBC code
- Snap-Lock™ collar connects to standard 4" or snaps without clamps to other snap-lock collars



AEV304 Intake

Dia.	Tail	Flapper	Screen	Each #	Qty	Case #	Package
4"	female	n/a	¼"x¼", ¼" round holes	10189	8	110189	Bulk

AEV320 Dryer Vent

Dia.	Tail	Flapper	Screen	Each #	Qty	Case #	Package
4"	female	flapper	n/a	10166	8	110166	Display Card
4"	female	flapper	n/a	10139	8	110139	Bulk
4"	male	flapper	n/a	10200	8	110200	Bulk

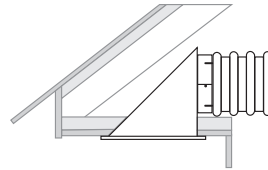

AEV304 10189

AEV324 Exhaust

Dia.	Tail	Flapper	Screen	Each #	Qty	Case #	Package
4"	female	flapper	¼"x¼", ¼" round holes	10188	8	110188	Bulk
4"	male	flapper	¼"x¼", ¼" round holes	10199	8	110199	Bulk

AFL349 Micro Louver Eave Vent

- Aluminum construction, fits flush into eave
- Fixed louver micro screen

Dia.	Tail/Connection	Screen	Each #	Qty	Case #	Package	UPC Ibl?
3"	ring	micro	10272	20	110272	Bulk	
4"	ring	micro	10273	20	110273	Bulk	
3"	3 ft V230 flexible aluminum	micro	10274	16	110274	Bulk	
4"	3 ft V230 flexible aluminum	micro	10275	16	110275	Bulk	
3"	3" collar	micro	10556	8	110556	Bulk	
4"	3" collar	micro	10555	8	110555	Bulk	
4"	3" collar	micro	10560	8	110560	Bulk	•



10274

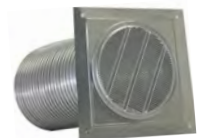

10275

Eave Vent Hoods - Plastic

RDV Round Soffit Vent

- Round soffit vent for intake or exhaust
- UV Stabilized polymer resin with molded in mesh bug screen
- Made in Canada by Primex



Dia.	Tail	Color	Screen	Each #	Qty	Case #	Package
4"	1.7	white	bug screen	RDV4S01	70	1RDV4S01	Bulk
6"	1.4	white	bug screen	RDV6S01	30	1RDV6S01	Bulk

EVE Under Eave Vent

- UV inhibitor added plastic vent handles up to 5" Dia.
- Use for bathroom exhaust
- Backdraft dampers
- Made in Canada



Dia.	Color	Each #	Qty	Case #	Package
up to 5"	White	11574	10	111574	Bulk

SV28 Exhaust

- UV stabilized polymer resin one piece design
- Can be used with adapter sold separately (see page 35)
- Back draft damper
- Made in Canada by Primex



Dia.	Tail	Color	Screen	Each #	Qty	Case #	Package
4"-8"	n/a	White	removable ½" x ½"	SV2801	6	1SV2801	Bulk

SV2801 SHOWN ABOVE WITH ADAPTER SOLD SEPARATELY PG 35

18 Eave Vent Hoods - Plastic (continued)

SV Soffit Vent Exhaust

- UV stabilized polymer resin one piece design, no leaky seams, with back draft damper
- Made in Canada by Primex

Dia.	Tail	Color	Each #	Qty	Case #	Package
4"	3.3"	white	SV401	24	1SV401	Bulk
6"	4.5"	white	SV601	10	1SV601	Bulk



SV401

PEV620 - Plastic Eave Vent Exhaust

- Polypropylene molded plastic with 4 pre-drilled mounting holes
- Free swinging back draft flapper
- Can be used for bathroom fan or dryer vent

Dia.	Tail	Color	Each #	Qty	Case #	Package
3"	¾" ring	white	11830	12	111830	Bulk
3"	¾" ring	brown	11831	12	111831	Bulk
4"	¾" ring	white	11802	12	111802	Bulk
4"	¾" ring	brown	11803	12	111803	Bulk
3"	3" rigid aluminum tail	white	11806	12	111806	Bulk
3"	3" rigid aluminum tail	brown	11807	12	111807	Bulk
4"	3" rigid aluminum tail	white	11804	12	111804	Bulk
4"	3" rigid aluminum tail	brown	11805	12	111805	Bulk



11803



11804

PFL342 Plastic Fixed Louver Mini Louver Hood with 1/2" grid

- Polypropylene molded plastic with 4 mounting holes
- 5"-8" diameters have a 1/2" 1/2" molded fixed louver grid

Dia.	Tail	Color	Each #	Qty	Case #	Package
5"	flush	white	10896	12	110896	Bulk
5"	flush	brown	11005	12	111005	Bulk
6"	flush	white	10900	12	110900	Bulk
6"	flush	brown	11503	12	111503	Bulk
7"	flush	white	10904	12	110904	Bulk
7"	flush	brown	11013	12	111013	Bulk
8"	flush	white	10908	12	110908	Bulk
8"	flush	brown	11017	12	111017	Bulk
5"	snap ring	white	10894	12	110894	Bulk
5"	snap ring	brown	11003	12	111003	Bulk
6"	snap ring	white	10898	12	110898	Bulk
6"	snap ring	brown	11007	12	111007	Bulk
7"	snap ring	white	10902	12	110902	Bulk
7"	snap ring	brown	11011	12	111011	Bulk
8"	snap ring	white	10906	12	110906	Bulk
8"	snap ring	brown	11015	12	111015	Bulk



10894



11011



PROFILE SNAP RING

Plastic Fixed Louver Mini Louvers are good for eave and side wall venting. They can be used as intake or exhaust. They are not recommended for dryer venting.

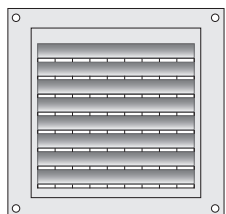

1/2" X 1/2" MOLDED
FIXED LOUVER GRID

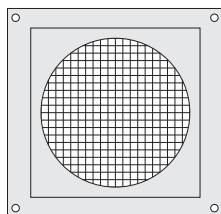

1/4" X 1/4" MOLDED
GRID ON THE INSIDE
FRAME

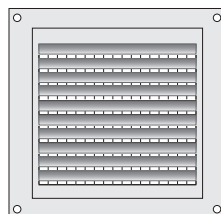

1/4" X 1/4" MOLDED
FIXED LOUVER GRID

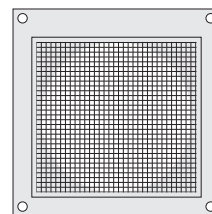

1/8" X 1/8"
WIRE MESH SCREEN

Grid Clarification:

- Fixed louvers create one grid
- Optional additional molded grid in frame

PFL344 Plastic Fixed Louver Mini Louver Hood with 1/4" grid

- Polypropylene molded plastic with 4 mounting holes
- 3" & 4" diameters have a 1/4" x 1/4" molded fixed louver grid
- 5" -8" diameters have 1/2" x 1/2" molded fixed louver grid plus a 1/4" x 1/4" molded grid on the inside frame

Dia.	Length	Color	Each #	Qty	Case #	Package	UPC
3"	flush	white	10975	12	110975	Bulk	
3"	flush	brown	10976	12	110976	Bulk	
4"	flush	white	10751	12	110751	Bulk	
4"	flush	brown	10752	12	110752	Bulk	
5"	flush	white	10897	12	110897	Bulk	
5"	flush	brown	11006	12	111006	Bulk	
6"	flush	white	10901	12	110901	Bulk	
6"	flush	brown	11010	12	111010	Bulk	
7"	flush	white	10905	12	110905	Bulk	
7"	flush	brown	11014	12	111014	Bulk	
8"	flush	white	10909	12	110909	Bulk	
8"	flush	brown	11018	12	111018	Bulk	
3"	snap ring	white	10694	12	110694	Bulk	
3"	snap ring	brown	10682	12	110682	Bulk	
4"	snap ring	white	10811	12	110811	Bulk	
4"	snap ring	brown	10972	12	110972	Bulk	
5"	snap ring	white	10895	12	110895	Bulk	
5"	snap ring	brown	11004	12	111004	Bulk	
6"	snap ring	white	10899	12	110899	Bulk	
6"	snap ring	white	11622	12	111622	Bulk	•
6"	snap ring	brown	11008	12	111008	Bulk	
7"	snap ring	white	10903	12	110903	Bulk	
7"	snap ring	brown	11012	12	111012	Bulk	
8"	snap ring	white	10907	12	110907	Bulk	
8"	snap ring	brown	11016	12	111016	Bulk	
3"	3" male collar	white	11599	12	111599	Bulk	•
4"	3" male collar	white	11609	12	111609	Bulk	•
3"	3" male collar	white	10695	12	110695	Bulk	
3"	3" male collar	brown	10681	12	110681	Bulk	
4"	3" male collar	white	10812	12	110812	Bulk	
4"	3" male collar	brown	10519	12	110519	Bulk	
6"	4" female tail	white	11918	4	111918	Bulk	
6"	4" female tail	brown	11919	4	111919	Bulk	
3"	10" female tail	white	10893	12	110893	Bulk	
3"	10" female tail	brown	10683	12	110683	Bulk	
4"	10" female tail	white	10813	12	110813	Bulk	
4"	10" female tail	brown	10971	12	110971	Bulk	
3"	3' flexible aluminum	white	11251	16	111251	Bulk	
3"	3' flexible aluminum	brown	10977	16	110977	Bulk	
4"	3' flexible aluminum	white	11249	16	111249	Bulk	
4"	3' flexible aluminum	brown	10973	16	110973	Bulk	

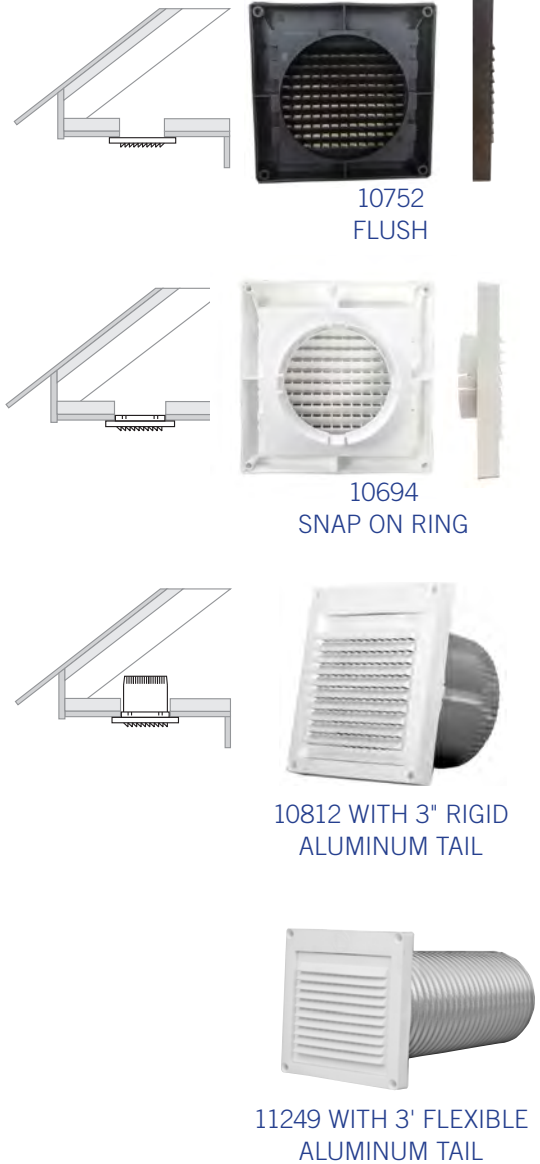

10752
FLUSH

10694
SNAP ON RING

10812 WITH 3" RIGID
ALUMINUM TAIL

11249 WITH 3' FLEXIBLE
ALUMINUM TAIL

PFL348 Mini Louver Hood with 1/8" screen

- Polypropylene molded plastic with 4 mounting holes
- Fixed louvers with a 1/4" x 1/4" molded fixed louver grid plus a 1/8" x 1/8" wire mesh screen under the fixed louver

Dia.	Tail	Color	Each #	Qty	Case #	Package
4"	flush	white	12344	12	112344	Bulk
4"	flush	brown	12345	12	112345	Bulk
4"	snap ring	white	10754	12	110754	Bulk
4"	snap ring	brown	10974	12	110974	Bulk
6"	flush	white	12347	12	112347	Bulk

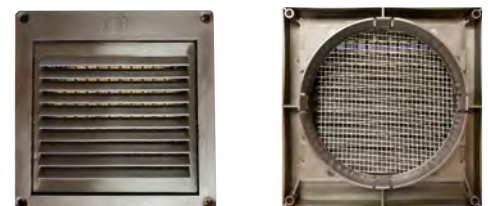

10974
RING & MESH SCREEN

20 Roof Vent Hoods - Aluminum

ARV Aluminum Roof Vent Heavy Gauge

- 020 mill finish aluminum
- Available with 4" collar and flush

ARV620 with flapper

Dia.	Tail	Flapper	Screen	Each #	Qty	Case #	Package
4"	flush	flapper	n/a	11751	1	011751	Ind. Box
4"	with collar	flapper	n/a	11746	1	011746	Ind. Box

ARV624 with flapper & screen

Dia.	Tail	Flapper	Screen	Each #	Qty	Case #	Package
4"	flush	flapper	¼"x¼" removable	11748	1	011748	Ind. Box
4"	with collar	flapper	¼"x¼" removable	11749	1	011749	Ind. Box
6"	flush	flapper	¼"x¼" removable	11795	1	011795	Ind. Box
6"	with collar	flapper	¼"x¼" removable	11796	1	011796	Ind. Box
6"-8" (3¼"x10")	flush	flapper	¼"x¼" removable	11754	1	011754	Ind. Box
7"	flush	flapper	¼"x¼" removable	11747	1	011747	Ind. Box
7"	with collar	flapper	¼"x¼" removable	11753	1	011753	Ind. Box



11754



11746



Roof Vent Hoods - Galvanized

Umbrella Cap™

- Galvanized steel, rigid ribbed construction
- Economical protection from rain and snow for flues and vent pipes

Tail Dia.	Cap Dia.	Each #	Qty	Case #	Package
3"	8"	10957	1	010957	Ind. Box
4"	8"	10958	1	010958	Ind. Box
5"	12"	10959	1	010959	Ind. Box
6"	12"	10960	1	010960	Ind. Box
7"	12"	10961	1	010961	Ind. Box
8"	12"	10962	1	010962	Ind. Box
9"	17"	10963	1	010963	Ind. Box
10"	17"	10964	1	010964	Ind. Box
12"	17"	10965	1	010965	Ind. Box



10959

Creative Crown Roof Vent Cap

- 26 gauge galvanized steel construction for corrosion resistance with riveted assembly
- Designed to fit over a Type B gas vent (see spec sheet for complete dimensions)
- Efficiently evacuates fumes from flues or pipes and helps eliminate down-drafts
- May also be used as a storm-proof air intake or exhaust

Tail Dia.	Cap Dia.	Each #	Qty	Case #	Package
3"	8	10921	1	010921	Ind. Box
4"	9	10922	1	010922	Ind. Box
5"	10.625	10923	1	010923	Ind. Box
6"	11	10924	1	010924	Ind. Box
7"	13.750	10925	1	010925	Ind. Box
8"	15.125	10926	1	010926	Ind. Box
9"	17.5	10927	1	010927	Ind. Box
10"	19	10928	1	010928	Ind. Box
12"	22	10929	1	010929	Ind. Box



10922

Broad Band Siphon Ventilator™

- 26 gauge galvanized steel construction with large unrestricted outlet
- Storm proof – helps prevent downdrafts
- Ribbed cap and wide band provide maximum protection and create strong siphoning action



10941

Tail Dia.	Overall Dia.	Height	Each #	Qty	Case #	Package
3"	11"	6"	10939	1	010939	Ind. Box
4"	11"	6"	10940	1	010940	Ind. Box
5"	15"	7.5"	10941	1	010941	Ind. Box
6"	15"	7.5"	10942	1	010942	Ind. Box
7"	15"	7.5"	10943	1	010943	Ind. Box
8"	15"	7.5"	10944	1	010944	Ind. Box
9"	20"	10"	10945	1	010945	Ind. Box
10"	20"	10"	10946	1	010946	Ind. Box
12"	20"	10"	10947	1	010947	Ind. Box

GRV Mill Finish Galvanized Roof Vent Heavy Gauge

- 26 gauge galvanized mill finish steel

GRV620 with flapper

Dia.	Tail	Flapper	Screen	Each #	Qty	Case #	Package
4"	flush	flapper	n/a	12120	1	012120	Ind. Box
4"	with collar	flapper	n/a	12121	1	012121	Ind. Box



11756

GRV624 with flapper & screen

Dia.	Tail	Flapper	Screen	Each #	Qty	Case #	Package
4"	flush	flapper	¼"x¼" removable	11755	1	011755	Ind. Box
4"	with collar	flapper	¼"x¼" removable	11756	1	011756	Ind. Box
6"	flush	flapper	¼"x¼" removable	11793	1	011793	Ind. Box
6"	with collar	flapper	¼"x¼" removable	11794	1	011794	Ind. Box
6"-8" (3¼"x10")	flush	flapper	¼"x¼" removable	11772	1	011772	Ind. Box
7"	flush	flapper	¼"x¼" removable	11773	1	011773	Ind. Box
7"	with collar	flapper	¼"x¼" removable	11868	1	011868	Ind. Box
10"	flush	flapper	¼"x¼" removable	11774	1	011774	Ind. Box

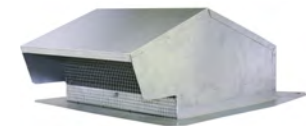

11772

Roof Vent Hoods - Galvanized Black Powder Coat

GRV Black Galvanized Roof Vent Heavy Gauge

- 26 gauge galvanized steel with black powder coat finish

GRV820 with flapper

Dia.	Tail	Flapper	Screen	Each #	Qty	Case #	Package
4"	flush	flapper	n/a	12642	1	012642	Ind. Box
4"	with collar	flapper	n/a	12643	1	012643	Ind. Box



02635

GRV824 with flapper & screen

Dia.	Tail	Flapper	Screen	Each #	Qty	Case #	Package
4"	with collar	flapper	¼"x¼" removable	12635	1	012635	Ind. Box
4"	with collar	flapper	¼"x¼" removable	12645	1	012645	Display Box
4"	flush	flapper	¼"x¼" removable	12636	1	012636	Ind. Box
4"	flush	flapper	¼"x¼" removable	12646	1	012646	Display Box
6"	flush	flapper	¼"x¼" removable	12632	1	012632	Ind. Box
6"	with collar	flapper	¼"x¼" removable	12633	1	012633	Ind. Box
7"	with collar	flapper	¼"x¼" removable	12639	1	012639	Ind. Box
6"-8" (3¼"x10")	flush	flapper	¼"x¼" removable	12634	1	012634	Ind. Box
10"	flush	flapper	¼"x¼" removable	12638	1	012638	Ind. Box



12636

Kit 012640 includes: Roof Cap, 4" x 8' UL® 181 Foil Duct, one 3-4" plastic increaser reducer, two ZipTorq clamps

4"	with collar	flapper	¼"x¼" removable	12640	1	012640	Display Box
----	-------------	---------	-----------------	-------	---	--------	-------------

22 Roof Vent Hoods - Plastic

RV28 Gooseneck Roof Cap

- UV protected polymer resin, one piece, seamless construction, 26.5 square inches mouth opening
- 4" thru 8" snap-in adapters available separately (See page 35)
- Made in Canada by Primex/Menzies

Dia.	Color	Mouth	Damper	Screen	Each #	Qty	Case #	Package
4"-8"	black	wide	removable	removable ½" x ½"	RV2825	5	1RV2825	Bulk

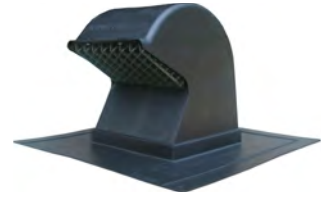

RVL28 Low Profile Roof Cap

- UV protected polymer resin, one piece, seamless construction, 27.8 square inch mouth opening
- 4" thru 8" snap-in adapters available separately (See page 35)
- Made in Canada by Primex/Menzies

Dia.	Color	Mouth	Damper	Screen	Each #	Qty	Case #	Package
4"-8"	black	wide	removable	removable ½" x ½"	RVL2825	6	1RVL2825	Bulk



RV20 Low Profile Roof Vent Kit

- UV protected polymer resin, one piece, seamless construction with 20 square inches of "free area"
- 4" 5" 6" adapter included
- Made in Canada by Primex/Menzies

Dia.	Color	Mouth	Damper	Screen	Each #	Qty	Case #	Package
4"-5"-6"	black	wide	removable	fixed ½" x ½"	RV2025	10	1RV2025	Bulk



duraFlo® Roof Exhaust Vent Cap "New Generation"

- Heavy duty black plastic (polypropylene), modified for impact and UV resistance
- Grid/Grill for use in bathroom vent installation
Do not use grid/grill when used as dryer vent
- Made in Canada by Canplas / Ipex

Dia.	Color	Use for:	Collar	Flapper	Grid/Grill	Each #	Qty	Case #	Package
4"	Black	dryer/bathroom vent (6014)	2.635"	flapper	molded	12425	6	112425	Bulk
4"	Black	dryer/bathroom vent (6014)	2.635"	flapper	molded	12425	90	612425	Skid
4"	Black	dryer/bathroom vent (6015)	flush	flapper	molded	12426	10	112426	Bulk
4"	Black	dryer/bathroom vent (6015)	flush	flapper	molded	12426	150	612426	Skid



12425 COLLAR



12426 FLUSH

UV Roof Vent

- High impact polyethylene plastic
- Bathroom and dryer venting for steep roof
- Made in Canada by Menzies

Dia.	Color	Damper	Screen	Each #	Qty	Case #	Package
4"	black	removable	removable ½" x ½"	UV440	4	1UV440	Bulk
6"	black	removable	removable ½" x ½"	UV640	4	1UV640	Bulk



SV50 Black Static Roof Vent

- High density polyethylene plastic
- 50 sq inch free area; internally screened
- 7" x 10" opening size
- Made in Canada by Menzies

Dia.	Color	Damper	Screen	Each #	Qty	Case #	Package
7" x 10"	black	none	internal	SV5040	4	1SV5040	Bulk



ARR Aluminum Rectangular Hood

- 020 aluminum
- Fully assembled riveted construction, no caulk
- Foam flapper seals for quiet closure

ARR630

Dia.	Tail	Mouth	Flapper	Screen	Each #	Qty	Case #	Package
3.25 x 10"	5"	rectangular	spring flapper	n/a	11929	14	111929	Bulk
3.25 x 10"	11"	rectangular	spring flapper	n/a	11377	8	111377	Bulk

ARR634

Dia.	Tail	Mouth	Flapper	Screen	Each #	Qty	Case #	Package
3.25 x 10"	11"	rectangular	flapper	¼"x¼"	12322	8	112322	Bulk

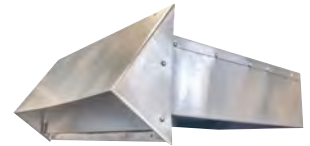

ARR630 11377
NO SCREEN



ARR634 12322
SCREEN & FLAPPER

AWM Aluminum Wide Mouth Hood

- 012 aluminum face, 010 aluminum tail
- Tailpipe connected with 360°mechanical seam

AWM320 with flapper

Dia.	Tail	Mouth	Flapper	Screen	Each #	Qty	Case #	Package
4"	flush	wide	flapper	n/a	10557	24	110557	Bulk
4"	4 in	wide	flapper	n/a	10791	18	110791	Bulk
3"	11.5"	wide	flapper	n/a	10270	12	110270	Bulk
3"	11.5"	wide	flapper	n/a	10328	4	110328	Ind. Box
4"	11.5"	wide	flapper	n/a	10170	6	110170	Display Tray
4"	11.5"	wide	flapper	n/a	10271	12	110271	Bulk
4"	11.5"	wide	flapper	n/a	10326	4	110326	Ind. Box

AWM324 with flapper & 1/4" screen

Dia.	Tail	Mouth	Flapper	Screen	Each #	Qty	Case #	Package
4"	flush	wide	flapper	¼"x¼"	10786	24	110786	Bulk
4"	11.5"	wide	flapper	¼"x¼"	10684	12	110684	Bulk

AWM328 with flapper & 1/8" screen

Dia.	Tail	Mouth	Flapper	Screen	Each #	Qty	Case #	Package
4"	flush	wide	flapper	1/8 x 1/8	12549	24	112549	Bulk

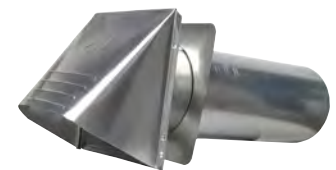

AWM320 10271

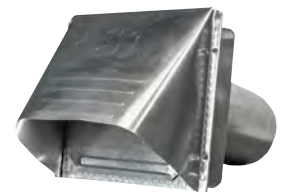

AWM324 10684



AWM328 12549

ASM Aluminum Standard Mouth Hood

- 012 aluminum face, 010 aluminum tail
- Tailpipe connected with 360°mechanical seam

ASM320 with flapper

Dia.	Tail	Mouth	Flapper	Screen	Each #	Qty	Case #	Package
3"	11.5"	standard	flapper	n/a	10276	12	110276	Bulk
3"	11.5"	standard	flapper	n/a	10278	4	110278	Ind. Box
4"	11.5"	standard	flapper	n/a	10277	12	110277	Bulk
4"	11.5"	standard	flapper	n/a	10279	4	110279	Ind. Box



ASM320

24 Wall Vent Hoods - Heavy Aluminum

Aluminum Wide Mouth 020 Aluminum

- 020 Aluminum, meets most building codes
- Riveted construction, no caulk
- Mouth opening exceeds pipe area
- 4 mounting holes for secure connections

AWM604 with 1/4" screen

Dia.	Tail	Flapper	Screen	Each #	Qty	Case #	Pkg
4"	flush	n/a	1/4"x1/4" removable	11173	20	111173	Bulk
4"	6"	n/a	1/4"x1/4" removable	11115	12	111115	Bulk
4"	11"	n/a	1/4"x1/4" removable	11105	12	011106	Bulk
5"	flush	n/a	1/4"x1/4" removable	12430	12	112430	Bulk
5"	6"	n/a	1/4"x1/4" removable	12431	12	112431	Bulk
5"	11"	n/a	1/4"x1/4" removable	12432	6	112432	Bulk
6"	flush	n/a	1/4"x1/4" removable	12433	12	112433	Bulk
6"	6"	n/a	1/4"x1/4" removable	12434	12	112434	Bulk
6"	11"	n/a	1/4"x1/4" removable	12435	6	112435	Bulk
7"	flush	n/a	1/4"x1/4" removable	12436	12	112436	Bulk
7"	6"	n/a	1/4"x1/4" removable	12437	12	112437	Bulk
7"	11"	n/a	1/4"x1/4" removable	12438	6	112438	Bulk
8"	flush	n/a	1/4"x1/4" removable	11181	12	111181	Bulk
8"	6"	n/a	1/4"x1/4" removable	11122	10	111122	Bulk
8"	11"	n/a	1/4"x1/4" removable	11112	6	111112	Bulk
10"	flush	n/a	1/4"x1/4" removable	11183	2	111183	Bulk
10"	6"	n/a	1/4"x1/4" removable	11123	2	111123	Bulk
10"	11"	n/a	1/4"x1/4" removable	11113	1	011113	Ind Box
12"	flush	n/a	1/4"x1/4" removable	11185	2	111185	Bulk
12"	6"	n/a	1/4"x1/4" removable	11124	2	111124	Bulk
12"	11"	n/a	1/4"x1/4" removable	11114	1	011114	Ind Box

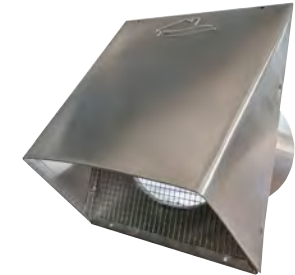
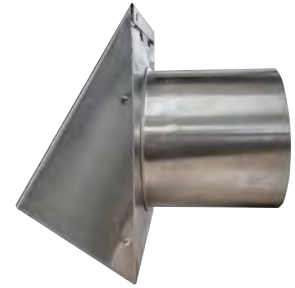

AWM604
1/4" SCREEN



AWM608
1/8" SCREEN

AWM608 with 1/8" screen

Dia.	Tail	Flapper	Screen	Each #	Qty	Case #	Pkg
6"	flush	n/a	1/8" x 1/8" removable	12553	12	112553	Bulk

AWM620 with flapper

Dia.	Tail	Flapper	Screen	Each #	Qty	Case #	Pkg
4"	flush	flapper	n/a	11159	20	111159	Bulk
4"	6"	flapper	n/a	11145	12	111145	Bulk
4"	11"	flapper	n/a	11147	12	011148	Bulk
5"	flush	flapper	n/a	12439	12	112439	Bulk
5"	6"	flapper	n/a	12440	12	112440	Bulk
5"	11"	flapper	n/a	12441	6	112441	Bulk
6"	flush	flapper	n/a	12442	12	112442	Bulk
6"	6"	flapper	n/a	12443	12	112443	Bulk
6"	11"	flapper	n/a	12444	6	112444	Bulk
7"	flush	flapper	n/a	12445	12	112445	Bulk
7"	6"	flapper	n/a	12446	12	112446	Bulk
7"	11"	flapper	n/a	12447	6	112447	Bulk
8"	flush	flapper	n/a	11167	12	111167	Bulk
8"	6"	flapper	n/a	11071	10	111071	Bulk
8"	6"	flapper	n/a	12010	1	112010	Ind Box
8"	11"	flapper	n/a	11102	6	111102	Bulk
10"	flush	flapper	n/a	11169	2	111169	Bulk
10"	6"	flapper	n/a	11072	2	111072	Bulk
10"	11"	flapper	n/a	11103	1	011103	Ind Box
12"	flush	flapper	n/a	11171	2	111171	Bulk
12"	6"	flapper	n/a	11073	2	111073	Bulk
12"	11"	flapper	n/a	11104	1	011104	Ind Box

New:
Flapper features
channel for sound
dampening foam



AWM620
FLAPPER

AWM624 with flapper & 1/4" screen

Dia.	Tail	Flapper	Screen	Each #	Qty	Case #	Pkg
4"	flush	flapper	1/4"x1/4" removable	11187	20	111187	Bulk
4"	6"	flapper	1/4"x1/4" removable	11056	12	111056	Bulk
4"	11"	flapper	1/4"x1/4" removable	11045	12	011046	Bulk
5"	flush	flapper	1/4"x1/4" removable	12448	12	112448	Bulk
5"	6"	flapper	1/4"x1/4" removable	12449	12	112449	Bulk
5"	11"	flapper	1/4"x1/4" removable	12450	6	112450	Bulk
6"	flush	flapper	1/4"x1/4" removable	12451	12	112451	Bulk
6"	6"	flapper	1/4"x1/4" removable	12452	12	112452	Bulk
6"	11"	flapper	1/4"x1/4" removable	12453	6	112453	Bulk
7"	flush	flapper	1/4"x1/4" removable	12454	12	112454	Bulk
7"	6"	flapper	1/4"x1/4" removable	12455	12	112455	Bulk
7"	11"	flapper	1/4"x1/4" removable	12456	6	112456	Bulk
8"	flush	flapper	1/4"x1/4" removable	11195	12	111195	Bulk
8"	6"	flapper	1/4"x1/4" removable	11063	10	111063	Bulk
8"	11"	flapper	1/4"x1/4" removable	11051	6	111051	Bulk
10"	flush	flapper	1/4"x1/4" removable	11197	2	111197	Bulk
10"	6"	flapper	1/4"x1/4" removable	11064	2	111064	Bulk
10"	11"	flapper	1/4"x1/4" removable	11052	1	011052	Ind Box
12"	n/a	flapper	1/4"x1/4" removable	11199	2	111199	Bulk
12"	6"	flapper	1/4"x1/4" removable	11065	2	111065	Bulk
12"	11"	flapper	1/4"x1/4" removable	11053	1	011053	Ind Box



AWM624
FLAPPER & SCREEN

New:
Flapper features
channel for sound
dampening foam

AWM628 with flapper & 1/8" screen

Dia.	Tail	Flapper	Screen	Each #	Qty	Case #	Pkg
5"	11"	flapper	1/8" x 1/8" removable	12550	6	112550	Bulk
10"	flush	flapper	1/8" x 1/8" removable	12554	2	112554	Bulk

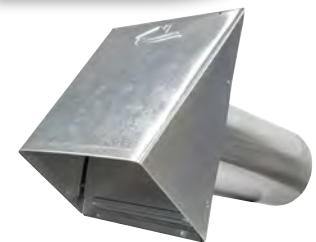

AWM628
FLAPPER & SCREEN

AWM630 with spring flapper

Dia.	Tail	Flapper	Screen	Each #	Qty	Case #	Pkg
4"	flush	spring flapper	n/a	11813	20	111813	Bulk
4"	6"	spring flapper	n/a	11820	12	111820	Bulk
5"	6"	spring flapper	n/a	12457	12	112457	Bulk
6"	flush	spring flapper	n/a	12458	12	112458	Bulk
6"	3"	spring flapper	n/a	12459	6	112459	Bulk
6"	6"	spring flapper	n/a	12460	12	112460	Bulk
6"	6"	spring flapper	n/a	12461	1	012461	Ind Box
7"	6"	spring flapper	n/a	12462	12	112462	Bulk
8"	6"	spring flapper	n/a	11823	10	111823	Bulk
8"	6"	spring flapper	n/a	12085	1	012085	Ind Box
10"	6"	spring flapper	n/a	11824	2	111824	Bulk
12"	6"	spring flapper	n/a	11825	2	111825	Bulk



AWM630
FLAPPER

AWM634 with spring flapper & 1/4" screen

Dia.	Tail	Flapper	Screen	Each #	Qty	Case #	Pkg
4"	flush	spring flapper	1/4"x1/4" removable	12590	20	112590	Bulk
4"	6"	spring flapper	1/4"x1/4" removable	12495	12	112495	Bulk
5"	flush	spring flapper	1/4"x1/4" removable	12591	12	112591	Bulk
5"	6"	spring flapper	1/4"x1/4" removable	12493	12	112493	Bulk
6"	flush	spring flapper	1/4"x1/4" removable	12463	12	112463	Bulk
6"	6"	spring flapper	1/4"x1/4" removable	12464	12	112464	Bulk
7"	flush	spring flapper	1/4"x1/4" removable	12593	12	112593	Bulk
7"	6"	spring flapper	1/4"x1/4" removable	12496	12	112496	Bulk
8"	flush	spring flapper	1/4"x1/4" removable	12594	12	112594	Bulk
8"	6"	spring flapper	1/4"x1/4" removable	12497	10	112497	Bulk
10"	flush	spring flapper	1/4"x1/4" removable	12595	2	112595	Bulk
10"	6"	spring flapper	1/4"x1/4" removable	12498	2	112498	Bulk
12"	flush	spring flapper	1/4"x1/4" removable	12596	2	112596	Bulk
12"	6"	spring flapper	1/4"x1/4" removable	12499	2	112499	Bulk



AWM634
FLAPPER & SCREEN

26 Wall Vent Hoods - Galvanized Paintable

Galvanized Wide Mouth P-Tanium™ 26 gauge

- 26 gauge P-Tanium™ paintable galvanized steel with plain face
- Mouth opening exceeds pipe area for best airflow
- Riveted construction, no caulk
- 4 mounting holes for secure connections

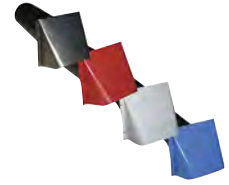

GWM704 with 1/4" screen

Dia.	Tail Length	Flapper	Screen	Each #	Qty	Case #	Pkg
4"	flush	n/a	¼"x¼" removable	12042	20	112042	Bulk
4"	6"	n/a	¼"x¼" removable	12067	12	112067	Bulk
4"	11"	n/a	¼"x¼" removable	12068	12	112068	Bulk
5"	flush	n/a	¼"x¼" removable	12501	12	112501	Bulk
5"	6"	n/a	¼"x¼" removable	12502	12	112502	Bulk
5"	11"	n/a	¼"x¼" removable	12503	6	112503	Bulk
6"	flush	n/a	¼"x¼" removable	12504	12	112504	Bulk
6"	6"	n/a	¼"x¼" removable	12505	12	112505	Bulk
6"	11"	n/a	¼"x¼" removable	12506	6	112506	Bulk
7"	flush	n/a	¼"x¼" removable	12507	12	112507	Bulk
7"	6"	n/a	¼"x¼" removable	12508	12	112508	Bulk
7"	11"	n/a	¼"x¼" removable	12509	6	112509	Bulk
8"	flush	n/a	¼"x¼" removable	12115	12	112115	Bulk
8"	6"	n/a	¼"x¼" removable	12243	10	112243	Bulk
8"	11"	n/a	¼"x¼" removable	12245	6	112245	Bulk



12506

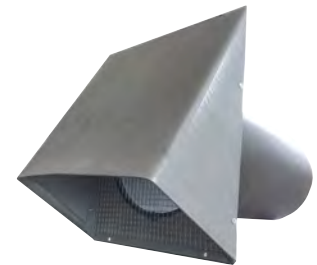

GWM704

GWM708 with 1/8" screen

Dia.	Tail Length	Flapper	Screen	Each #	Qty	Case #	Pkg
4"	flush	n/a	1/8" x 1/8" removable	12558	12	112558	Bulk

GWM720 with flapper

Dia.	Tail Length	Flapper	Screen	Each #	Qty	Case #	Pkg
4"	flush	flapper	n/a	12041	20	112041	Bulk
4"	6"	flapper	n/a	12219	12	112219	Bulk
4"	11"	flapper	n/a	11708	12	111708	Bulk
5"	flush	flapper	n/a	12510	12	112510	Bulk
5"	6"	flapper	n/a	12511	12	112511	Bulk
5"	11"	flapper	n/a	12512	6	112512	Bulk
6"	flush	flapper	n/a	12513	12	112513	Bulk
6"	6"	flapper	n/a	12514	12	112514	Bulk
6"	11"	flapper	n/a	12515	6	112515	Bulk
7"	flush	flapper	n/a	12516	12	112516	Bulk
7"	6"	flapper	n/a	12517	12	112517	Bulk
7"	11"	flapper	n/a	12518	6	112518	Bulk
8"	flush	flapper	n/a	12418	12	112418	Bulk
8"	6"	flapper	n/a	12070	10	112070	Bulk
8"	11"	flapper	n/a	11841	6	111841	Bulk



GWM720

GWM724 with flapper & 1/4" screen

Dia.	Tail Length	Flapper	Screen	Each #	Qty	Case #	Pkg
4"	flush	flapper	¼"x¼" removable	12420	20	112420	Bulk
4"	6"	flapper	¼"x¼" removable	12210	12	112210	Bulk
4"	11"	flapper	¼"x¼" removable	12211	12	112211	Bulk
5"	flush	flapper	¼"x¼" removable	12519	12	112519	Bulk
5"	6"	flapper	¼"x¼" removable	12520	12	112520	Bulk
5"	11"	flapper	¼"x¼" removable	12521	6	112521	Bulk
6"	flush	flapper	¼"x¼" removable	12522	12	112522	Bulk
6"	6"	flapper	¼"x¼" removable	12523	12	112523	Bulk
6"	11"	flapper	¼"x¼" removable	12524	6	112524	Bulk
7"	flush	flapper	¼"x¼" removable	12525	12	112525	Bulk
7"	6"	flapper	¼"x¼" removable	12526	12	112526	Bulk
7"	11"	flapper	¼"x¼" removable	12527	6	112527	Bulk
8"	flush	flapper	¼"x¼" removable	12084	12	112084	Bulk
8"	6"	flapper	¼"x¼" removable	12242	10	112242	Bulk
8"	11"	flapper	¼"x¼" removable	12323	6	112323	Bulk

New:
Flapper features
channel for sound
dampening foam



GWM724

GWM728 with flapper & 1/8" screen

Dia.	Tail Length	Flapper	Screen	Each #	Qty	Case #	Pkg
4"	6"	flapper	1/8" x 1/8" removable	12557	12	112557	Bulk



GWM730

GWM730 with spring flapper

Dia.	Tail Length	Flapper	Screen	Each #	Qty	Case #	Pkg
4"	flush	spring flapper	n/a	12580	20	112580	Bulk
4"	6"	spring flapper	n/a	11843	12	111843	Bulk
6"	flush	spring flapper	n/a	12584	12	112584	Bulk
6"	6"	spring flapper	n/a	12583	12	112583	Bulk

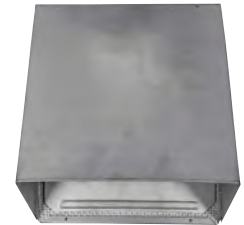

FLAPPER & SCREEN

GWM734 with spring flapper & 1/4" screen

Dia.	Tail Length	Flapper	Screen	Each #	Qty	Case #	Pkg
4"	flush	spring flapper	1/4"x1/4" removable	12581	20	112581	Bulk
4"	6"	spring flapper	1/4"x1/4" removable	11842	12	111842	Bulk
6"	flush	spring flapper	1/4"x1/4" removable	12582	12	112582	Bulk
6"	6"	spring flapper	1/4"x1/4" removable	12528	12	112528	Bulk
8"	flush	spring flapper	1/4"x1/4" removable	12588	12	112588	Bulk

Galvanized Wide Mouth P-Tanium™ 30 gauge

GWM404 with 1/4" screen

Dia.	Tail Length	Mouth	Flapper	Screen	Each #	Qty	Case #	Package
4"	flush	wide	n/a	1/4"x1/4"	12410	24	112410	Bulk



GWM420 FACE

GWM408 with 1/8" screen

Dia.	Tail Length	Mouth	Flapper	Screen	Each #	Qty	Case #	Package
4"	flush	wide	n/a	1/8"x1/8"	12555	24	112555	Bulk

GWM420 with flapper

Dia.	Tail Length	Mouth	Flapper	Screen	Each #	Qty	Case #	Package	UPC Label
3"	11.5"	wide	flapper	n/a	10887	12	110887	Bulk	
4"	flush	wide	flapper	n/a	11157	24	111157	Bulk	
4"	11.5"	wide	flapper	n/a	10648	6	110648	Display Tray	
4"	11.5"	wide	flapper	n/a	11430	8	111430	Display Card	
4"	11.5"	wide	flapper	n/a	10889	12	110889	Bulk	



GWM424 10889

GWM424 with flapper & 1/4" screen

Dia.	Tail Length	Mouth	Flapper	Screen	Each #	Qty	Case #	Package
4"	flush	wide	flapper	1/4"x1/4"	12341	24	112341	Bulk
4"	11.5"	wide	flapper	1/4"x1/4"	10891	12	110891	Bulk



GWM424 10891

GWM428 with flapper & 1/8" screen

Dia.	Tail Length	Mouth	Flapper	Screen	Each #	Qty	Case #	Package
4"	flush	wide	flapper	1/8"x1/8"	12556	24	112556	Bulk

Galvanized Standard Mouth P-Tanium™ 30 gauge

GSM404 with screen

Dia.	Tail Length	Mouth	Flapper	Screen	Each #	Qty	Case #	Package
4"	11.5"	standard	n/a	1/4"x1/4"	10729	12	110729	Bulk

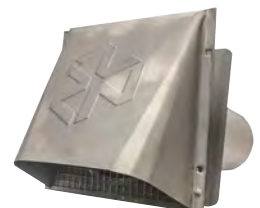

GWM404 10729

GSM420 with flapper

Dia.	Tail Length	Mouth	Flapper	Screen	Each #	Qty	Case #	Package
3"	11.5"	standard	flapper	n/a	10883	12	110883	Bulk
4"	flush	standard	flapper	n/a	11419	24	111419	Bulk
4"	11.5"	standard	flapper	n/a	10885	12	110885	Bulk
4"	11.5"	standard	flapper	n/a	10750	4	110750	Ind. Box

28 Wall Vent Hoods - Heavy Galvanized

Galvanized Wide Mouth Mill Finish 26 gauge

- 26 gauge galvanized steel
- Riveted construction, no caulk
- Mouth opening exceeds pipe area
- 4 mounting holes for secure connections

GWM602 with screen

Dia.	Tail	Flapper	Screen	Each #	Qty	Case #	Pkg
4"	6"	n/a	½"x½" removable	11427	12	111427	Bulk



GWM602 11427
½" X ½" SCREEN

GWM604 with screen

Dia.	Tail	Flapper	Screen	Each #	Qty	Case #	Pkg
4"	flush	n/a	¼"x¼" removable	11215	20	111215	Bulk
4"	6"	n/a	¼"x¼" removable	11076	12	111076	Bulk
4"	11"	n/a	¼"x¼" removable	11087	12	011088	Bulk
5"	flush	n/a	¼"x¼" removable	12465	12	112465	Bulk
5"	6"	n/a	¼"x¼" removable	12466	12	112466	Bulk
5"	11"	n/a	¼"x¼" removable	12467	6	112467	Bulk
6"	flush	n/a	¼"x¼" removable	12468	12	112468	Bulk
6"	6"	n/a	¼"x¼" removable	12469	12	112469	Bulk
6"	11"	n/a	¼"x¼" removable	12470	6	112470	Bulk
7"	flush	n/a	¼"x¼" removable	12471	12	112471	Bulk
7"	6"	n/a	¼"x¼" removable	12472	12	112472	Bulk
7"	11"	n/a	¼"x¼" removable	12473	6	112473	Bulk
8"	flush	n/a	¼"x¼" removable	11223	12	111223	Bulk
8"	6"	n/a	¼"x¼" removable	11082	10	111082	Bulk
8"	11"	n/a	¼"x¼" removable	11094	6	111094	Bulk
10"	flush	n/a	¼"x¼" removable	11225	2	111225	Bulk
10"	6"	n/a	¼"x¼" removable	11083	2	111083	Bulk
10"	11"	n/a	¼"x¼" removable	11095	1	011095	Ind Box
12"	flush	n/a	¼"x¼" removable	11227	2	111227	Bulk
12"	6"	n/a	¼"x¼" removable	11084	2	111084	Bulk
12"	11"	n/a	¼"x¼" removable	11096	1	011096	Ind Box

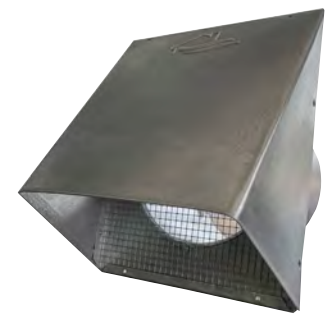

GWM604
¼" X ¼" SCREEN

GWM608 with screen

Dia.	Tail	Flapper	Screen	Each #	Qty	Case #	Pkg
6"	flush	n/a	1/8" x 1/8" removable	12621	12	112621	Bulk
8"	flush	n/a	1/8" x 1/8" removable	12623	12	112623	Bulk
10"	flush	n/a	1/8" x 1/8" removable	12624	2	112624	Bulk

GWM620 with flapper

Dia.	Tail	Flapper	Screen	Each #	Qty	Case #	Pkg
4"	flush	flapper	n/a	11201	20	111201	Bulk
4"	6"	flapper	n/a	11125	12	111125	Bulk
4"	11"	flapper	n/a	11135	12	011136	Bulk
5"	flush	flapper	n/a	12474	12	112474	Bulk
5"	6"	flapper	n/a	12475	12	112475	Bulk
5"	11"	flapper	n/a	12476	6	112476	Bulk
6"	flush	flapper	n/a	12477	12	112477	Bulk
6"	6"	flapper	n/a	12478	12	112478	Bulk
6"	11"	flapper	n/a	12479	6	112479	Bulk
7"	flush	flapper	n/a	12480	12	112480	Bulk
7"	6"	flapper	n/a	12481	12	112481	Bulk
7"	11"	flapper	n/a	12482	6	112482	Bulk
8"	flush	flapper	n/a	11209	12	111209	Bulk
8"	6"	flapper	n/a	11132	10	111132	Bulk
8"	11"	flapper	n/a	11142	6	111142	Bulk
10"	flush	flapper	n/a	11211	2	111211	Bulk
10"	6"	flapper	n/a	11133	2	111133	Bulk
10"	11"	flapper	n/a	11143	1	011143	Ind Box
12"	flush	flapper	n/a	11213	2	111213	Bulk
12"	6"	flapper	n/a	11134	2	111134	Bulk
12"	11"	flapper	n/a	11144	1	011144	Ind Box

New:
Flapper features
channel for sound
dampening foam

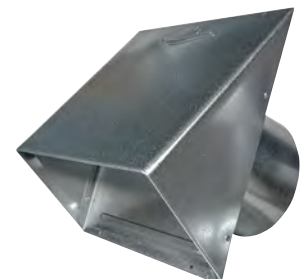

GWM620
FLAPPER

GWM624 with flapper & screen

Dia.	Tail	Flapper	Screen	Each #	Qty	Case #	Pkg
4"	flush	flapper	¼"x¼" removable	11229	20	111229	Bulk
4"	6"	flapper	¼"x¼" removable	11033	12	111033	Bulk
4"	11"	flapper	¼"x¼" removable	11022	12	011023	Bulk
5"	flush	flapper	¼"x¼" removable	12483	12	112483	Bulk
5"	6"	flapper	¼"x¼" removable	12484	12	112484	Bulk
5"	11"	flapper	¼"x¼" removable	12485	6	112485	Bulk
6"	flush	flapper	¼"x¼" removable	12486	12	112486	Bulk
6"	6"	flapper	¼"x¼" removable	12487	12	112487	Bulk
6"	11"	flapper	¼"x¼" removable	12488	6	112488	Bulk
7"	flush	flapper	¼"x¼" removable	12489	12	112489	Bulk
7"	6"	flapper	¼"x¼" removable	12490	12	112490	Bulk
7"	11"	flapper	¼"x¼" removable	12491	6	112491	Bulk
8"	flush	flapper	¼"x¼" removable	11237	12	111237	Bulk
8"	6"	flapper	¼"x¼" removable	11039	10	111039	Bulk
8"	11"	flapper	¼"x¼" removable	11028	6	111028	Bulk
10"	flush	flapper	¼"x¼" removable	11239	2	111239	Bulk
10"	6"	flapper	¼"x¼" removable	11040	2	111040	Bulk
10"	11"	flapper	¼"x¼" removable	11029	1	011029	Ind Box
12"	flush	flapper	¼"x¼" removable	11241	2	111241	Bulk
12"	6"	flapper	¼"x¼" removable	11041	2	111041	Bulk
12"	11"	flapper	¼"x¼" removable	11030	1	011030	Ind Box



GWM624 12487



GWM628 PN 12564



GWM628 PN 12564

GWM628 with flapper

Dia.	Tail	Flapper	Screen	Each #	Qty	Case #	Pkg
4"	flush	flapper	1/8" x 1/8" removable	12562	20	112562	Bulk
6"	flush	flapper	1/8" x 1/8" removable	12564	12	112564	Bulk
8"	flush	flapper	1/8" x 1/8" removable	12566	12	112566	Bulk
10"	flush	flapper	1/8" x 1/8" removable	12567	2	112567	Bulk

GWM630 with spring flapper

Dia.	Tail	Flapper	Screen	Each #	Qty	Case #	Pkg
4"	11"	spring flapper	n/a	11643	15	111643	Bulk
6"	11"	spring flapper	n/a	12492	6	112492	Bulk

Wall Vent Hoods - Galvanized

Mill Finish 30 gauge

- 30 gauge galvanized
- Riveted construction, no caulk

GWM320 Wide Mouth with flapper

Dia.	Tail Length	Mouth	Flapper	Screen	Each #	Qty	Case #	Package
3"	11.5	wide	flapper	n/a	10770	12	110770	Bulk
4"	flush	wide	flapper	n/a	10699	24	110699	Bulk
4"	11.5	wide	flapper	n/a	10771	12	110771	Bulk



GWM320 10771
WIDE MOUTH

GSM320 Standard Mouth with flapper

Dia.	Tail Length	Mouth	Flapper	Screen	Each #	Qty	Case #	Package
4"	11.5	standard	flapper	n/a	10732	12	110732	Bulk

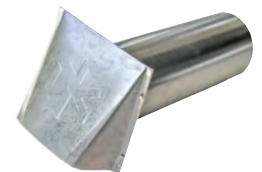

30 Wall Vent Hoods - Plastic

SM Side Wall Cap

- UV-stabilized durable polymer resin
- One-piece seamless design helps eliminate leaky joints while maximizing water protection
- Made in Canada by Primex

Dia.	Color	Flapper	Screen	Each #	Qty	Case #	Package
4"	white	spring	removable ½" x ½"	SM401	24	1SM401	Bulk
4"	light grey	spring	removable ½" x ½"	SM431	24	1SM431	Bulk
5"	light grey	spring	removable ½" x ½"	SM531	10	1SM531	Bulk
6"	white	spring	removable ½" x ½"	SM601	10	1SM601	Bulk
6"	light grey	spring	removable ½" x ½"	SM631	10	1SM631	Bulk

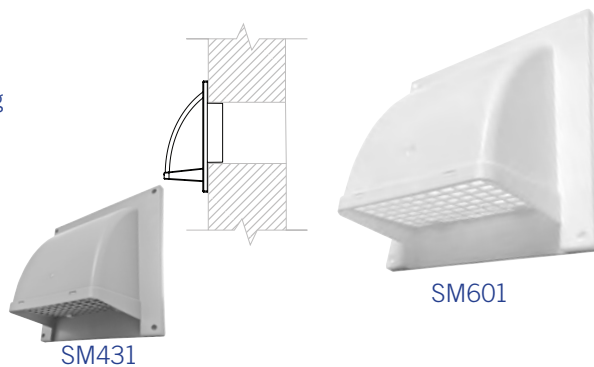

WC Wall Cap

- UV-stabilized durable polymer resin
- Drip edge to drain away water
- Screen is not removable
- Made in Canada by Primex

Dia.	Color	Mouth	Flapper	Screen	Each #	Qty	Case #	Package
4"	white	wide	removable spring	½" x ½"	WC401S	25	1WC401S	Bulk
4"	white	wide	removable spring	n/a	WC401SNS	25	1WC401SNS	Bulk
4"	taupe	wide	removable spring	½" x ½"	WC423S	25	1WC423S	Bulk
4"	taupe	wide	removable spring	n/a	WC423SNS	25	1WC423SNS	Bulk
4"	black	wide	removable spring	½" x ½"	WC425S	25	1WC425S	Bulk
4"	black	wide	removable spring	n/a	WC425SNS	25	1WC425SNS	Bulk
4"	dark grey	wide	removable spring	½" x ½"	WC428S	25	1WC428S	Bulk
4"	dark grey	wide	removable spring	n/a	WC428SNS	25	1WC428SNS	Bulk
4"	light grey	wide	removable spring	½" x ½"	WC431S	25	1WC431S	Bulk
4"	light grey	wide	removable spring	n/a	WC431SNS	25	1WC431SNS	Bulk
4"	tan	wide	removable spring	½" x ½"	WC445S	25	1WC445S	Bulk
4"	tan	wide	removable spring	n/a	WC445SNS	25	1WC445SNS	Bulk
4"	dark brown	wide	removable spring	½" x ½"	WC468S	25	1WC468S	Bulk
4"	dark brown	wide	removable spring	n/a	WC468SNS	25	1WC468SNS	Bulk
6"	white	wide	removable spring	½" x ½"	WC601S	10	1WC601S	Bulk
6"	taupe	wide	removable spring	½" x ½"	WC623S	10	1WC623S	Bulk
6"	black	wide	removable spring	½" x ½"	WC625S	10	1WC625S	Bulk
6"	dark grey	wide	removable spring	½" x ½"	WC628S	10	1WC628S	Bulk
6"	light grey	wide	removable spring	½" x ½"	WC631S	10	1WC631S	Bulk
6"	tan	wide	removable spring	½" x ½"	WC645S	10	1WC645S	Bulk
6"	dark brown	wide	removable spring	½" x ½"	WC668S	10	1WC668S	Bulk
7"	white	wide	removable	½" x ½"	WC701	2	1WC701	Bulk
7"	taupe	wide	removable	½" x ½"	WC723	2	1WC723	Bulk
8"	white	wide	removable	½" x ½"	WC801	2	1WC801	Bulk
8"	taupe	wide	removable	½" x ½"	WC823	2	1WC823	Bulk
8"	dark grey	wide	removable	½" x ½"	WC828	2	1WC828	Bulk



Accessories for PWM Plastic Wide Mouth Hoods

Description	Color	Grid/Guard	Each #	Qty	Case #	Package	UPC
Replacement flapper	white	na	12701	100	112701	Bulk	
Replacement flapper	brown	na	12703	100	112703	Bulk	
Replacement grid	white	removable ½" x ½"	12700	100	112700	Bulk	
Replacement grid	brown	removable ½" x ½"	12702	100	112702	Bulk	
Replacement guard	white	¾ spacing	12576	8	112576	Bulk	
Replacement guard	brown	¾ spacing	12577	8	112577	Bulk	
Universal pest guard	white	hinges for cleaning	11572	12	111572	Bulk	
Universal pest guard	white	hinges for cleaning	11573	12	111573	Display Label	•



PWM620 Plastic Wide Mouth Hood

- Polypropylene molded plastic
- Fully assembled tailpipe
- Four mounting holes

Dia.	Tail Length	Color	Flapper	Each #	Qty	Case #	Package	UPC
4"	flush	white	flapper	10766	8	110766	Bulk	
4"	flush	white	flapper	10766	392	010768	Skid (gaylord)	
4"	flush	brown	flapper	10767	8	110767	Bulk	
4"	flush	brown	flapper	10767	392	010769	Skid (gaylord)	
3"	1/2" ring	white	flapper	11373	8	111373	Bulk	
3"	1/2" ring	brown	flapper	11374	8	111374	Bulk	
4"	1/2" ring	white	flapper	10119	8	110119	Bulk	
4"	1/2" ring	white	flapper	10119	336	010723	Skid (gaylord)	
4"	1/2" ring	brown	flapper	10285	8	110285	Bulk	
4"	1/2" ring	brown	flapper	10285	336	010724	Skid (gaylord)	
3"	11"	white	flapper	11243	8	111243	Bulk	•
3"	11"	brown	flapper	11378	8	111378	Bulk	•
4"	11"	white	flapper	10179	6	010179	Display Tray	•
4"	11"	white	flapper	10164	8	110164	Display Card	•
4"	11"	white	flapper	10113	8	110113	Bulk	•
4"	11"	white	flapper	10330	4	110330	Ind. Box	•
4"	11"	brown	flapper	10410	8	110410	Display Card	•
4"	11"	brown	flapper	10177	6	110177	Display Tray	•
4"	11"	brown	flapper	10284	8	110284	Bulk	
4"	11"	brown	flapper	10332	4	110332	Ind. Box	

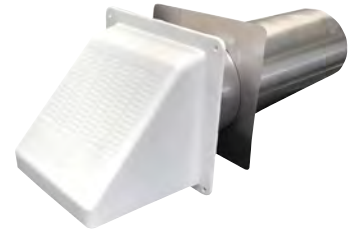

PWM620 4" WHITE

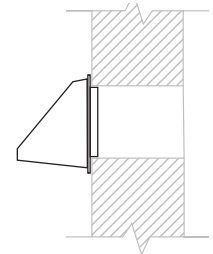

PWM620 WITH 1/2 RING

PWM622 Plastic Wide Mouth Hood with Grid

- Polypropylene molded plastic
- Fully assembled tailpipe
- Four mounting holes
- Snap-in removable 1/2" x 1/2" pest grid *Screens are not recommended for dryer venting*

Dia.	Tail Length	Color	Flapper	Grid	Each #	Qty	Case #	Package	UPC
4"	flush	white	flapper	removable 1/2" x 1/2"	11391	8	111391	Bulk	
4"	flush	brown	flapper	removable 1/2" x 1/2"	11392	8	111392	Bulk	
4"	1/2" ring	white	flapper	removable 1/2" x 1/2"	11732	8	111732	Bulk	
4"	1/2" ring	brown	flapper	removable 1/2" x 1/2"	11733	8	111733	Bulk	
3"	11"	white	flapper	removable 1/2" x 1/2"	11365	8	111365	Bulk	•
3"	11"	brown	flapper	removable 1/2" x 1/2"	11368	8	111368	Bulk	•
4"	11"	white	flapper	removable 1/2" x 1/2"	11381	8	111381	Bulk	•
4"	11"	brown	flapper	removable 1/2" x 1/2"	11384	8	111384	Bulk	•



PWM622 WITH SCREEN



PWM621 Plastic Wide Mouth Hood with Vertical Guard

- Polypropylene molded plastic
- Fully assembled tailpipe
- Four mounting holes
- Snap-in removable guard with vertical bars 3/4" apart *Screens are not recommended for dryer venting.*

Dia.	Tail Length	Color	Flapper	Guard	Each #	Qty	Case #	Package	UPC
4"	flush	white	flapper	3/4" spacing	12570	8	112570	Bulk	
4"	flush	brown	flapper	3/4" spacing	12571	8	112571	Bulk	
4"	11"	white	flapper	3/4" spacing	12574	8	112574	Bulk	•
4"	11"	brown	flapper	3/4" spacing	12575	8	112575	Bulk	•
		white		replacement	12576	25	112576	Bulk	
		brown		replacement	12577	25	112577	Bulk	



PWM621 WITH GUARD

PML320 Plastic Multi Louvered Hood

- Polypropylene molded plastic with freeswinging louvers
- Hoods with 11" tails include aluminum trim plates

Dia.	Tail	Color	# Louvers	Each#	Qty	Case #	Package	UPC
3"	flush	white	4	11149	24	111149	Bulk	
3"	flush	brown	4	11151	24	111151	Bulk	
4"	flush	white	4	11153	24	111153	Bulk	
4"	flush	brown	4	11155	24	111155	Bulk	
5"	flush	white	2	10832	12	110832	Bulk	
5"	flush	brown	2	10836	12	110836	Bulk	
6"	flush	white	3	10840	12	110840	Bulk	
6"	flush	white	3	12310	12	112310	Bulk	•
6"	flush	brown	3	10844	12	110844	Bulk	
6"	flush	brown	3	12311	12	112311	Bulk	•
7"	flush	white	3	10848	12	110848	Bulk	
7"	flush	brown	3	10852	12	110852	Bulk	
8"	flush	white	3	10856	12	110856	Bulk	
8"	flush	brown	3	10860	12	110860	Bulk	
3"	snap ring	white	4	10749	12	110749	Bulk	
3"	snap ring	brown	4	10872	12	110872	Bulk	
4"	snap ring	white	4	11424	12	111424	Display Card	•
4"	snap ring	white	4	10286	12	110286	Bulk	
4"	snap ring	brown	4	11545	12	111545	Display Card	•
4"	snap ring	brown	4	10287	12	110287	Bulk	
5"	snap ring	white	2	10830	12	110830	Bulk	
5"	snap ring	brown	2	10834	12	110834	Bulk	
6"	snap ring	white	3	10838	12	110838	Bulk	
6"	snap ring	brown	3	10842	12	110842	Bulk	
7"	snap ring	white	3	10846	12	110846	Bulk	
7"	snap ring	brown	3	10850	12	110850	Bulk	
8"	snap ring	white	3	10854	12	110854	Bulk	
8"	snap ring	brown	3	10858	12	110858	Bulk	
3"	11"	white	4	10280	12	110280	Bulk	
3"	11"	white	4	10334	4	110334	Ind. Box	•
3"	11"	brown	4	10281	12	110281	Bulk	
4"	11"	white	4	11412	12	111412	Display Card	•
4"	11"	white	4	10282	12	110282	Bulk	•
4"	11"	white	4	10336	4	110336	Ind. Box	•
4"	11"	white	4	10336	4	110336	Ind. Box	•
4"	11"	brown	4	11414	12	111414	Display Card	•
4"	11"	brown	4	10283	12	110283	Bulk	•
4"	11"	brown	4	10338	4	110338	Ind. Box	•

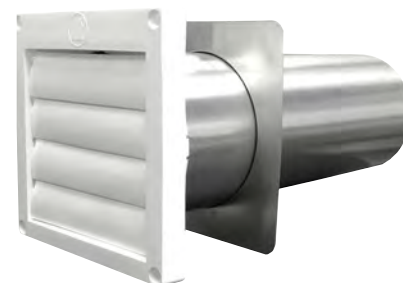

10282 4" X 11" WHITE

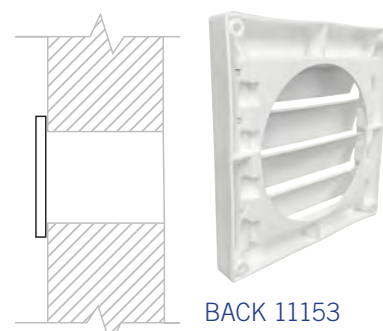

BACK 11153
FLUSH

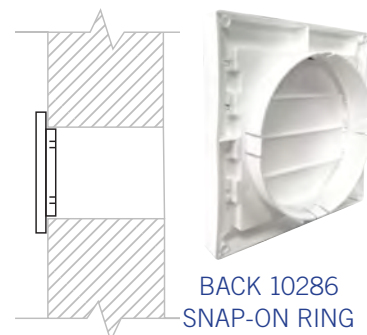

BACK 10286
SNAP-ON RING

PML320 Louvered Hood with unassembled tailpipe

- Unassembled tailpipe ships flat, assemble with reeves snap-lock
- Snap-On connecting ring
- Includes aluminum trim plate

Dia.	Tail	Color	# Louvers	Each #	Qty	Case #	Package
4"	snap ring	white	4	11692	12	111692	Bulk
4"	snap ring	brown	4	11734	12	111734	Bulk

Aluminum Tailpipe

- Ships flat, assemble onsite with Reeves Lock

Dia.	Length	Each #	Qty	Case #	Package
3"	11"	10866	24	110866	Bulk
4"	5.5"	12283	75	112283	Bulk
4"	11"	10867	24	110867	Bulk
5"	11"	10862	24	110862	Bulk
6"	11"	10863	24	110863	Bulk
7"	11"	10864	24	110864	Bulk
8"	11"	10865	24	110865	Bulk

- Four tabs
- Designed for the following models:
PWM620, PWM622, PWM621
PML320, PML324, PML328
- Not for J-Block

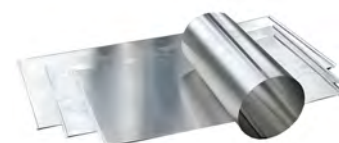

PML324 Plastic Multi Louvered Hood

- Polypropylene molded plastic with freeswinging louvers and 1/4" x 1/4" grid
- Faceplate only (no tailpipe)

Dia.	Tail	Color	Screen	# Louvers	Each	Qty	Case #	Package
4"	flush	white	¼"x¼"	4	10289	24	110289	Bulk
4"	flush	brown	¼"x¼"	4	10293	24	110293	Bulk
5"	flush	white	¼"x¼"	2	10833	12	110833	Bulk
5"	flush	brown	¼"x¼"	2	10837	12	110837	Bulk
6"	flush	white	¼"x¼"	3	10841	12	110841	Bulk
6"	flush	brown	¼"x¼"	3	10845	12	110845	Bulk
7"	flush	white	¼"x¼"	3	10849	12	110849	Bulk
7"	flush	brown	¼"x¼"	3	10853	12	110853	Bulk
8"	flush	white	¼"x¼"	3	10857	12	110857	Bulk
8"	flush	brown	¼"x¼"	3	10861	12	110861	Bulk
3"	snap ring	white	¼"x¼"	4	10340	12	110340	Bulk
3"	snap ring	brown	¼"x¼"	4	10342	12	110342	Bulk
4"	snap ring	white	¼"x¼"	4	10295	12	110295	Bulk
4"	snap ring	brown	¼"x¼"	4	10311	12	110311	Bulk
5"	snap ring	white	¼"x¼"	2	10831	12	110831	Bulk
5"	snap ring	brown	¼"x¼"	2	10835	12	110835	Bulk
6"	snap ring	white	¼"x¼"	3	10839	12	110839	Bulk
6"	snap ring	brown	¼"x¼"	3	10843	12	110843	Bulk
7"	snap ring	white	¼"x¼"	3	10847	12	110847	Bulk
7"	snap ring	brown	¼"x¼"	3	10851	12	110851	Bulk
8"	snap ring	white	¼"x¼"	3	10855	12	110855	Bulk
8"	snap ring	brown	¼"x¼"	3	10859	12	110859	Bulk



PML324
FACE

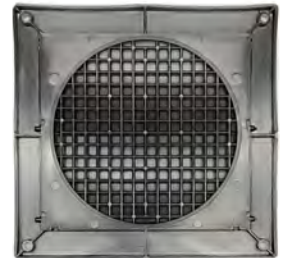

PML324
BACK ¼"X¼" GRID

PML328 Louvered Hood

- Polypropylene molded plastic
- Freeswinging louvers
- 1/8" x 1/8" wire mesh screen

Dia.	Tail	Color	Screen	# Louvers	Each #	Qty	Case #	Package
4"	flush	White	1/8"x1/8"	4	10291	24	110291	Bulk
4"	flush	Brown	1/8"x1/8"	4	10294	24	110294	Bulk
4"	snap ring	White	1/8"x1/8"	4	10288	12	110288	Bulk
4"	snap ring	Brown	1/8"x1/8"	4	10292	12	110292	Bulk



PML328
SCREEN & FLUSH



PML328
SCREEN & RING

Louver Replacements

- Snap-in replacement louvers

Color	Each #	Qty	Case #	Package
white	10003	100	110003	Bulk
brown	10004	100	110004	Bulk

J-Block

- Low profile plastic hood for brick, siding & stucco applications
- Weighted flapper design helps prevent wind noise and animal entry
- Snap Ring (flush and 11" tails) • Made in Canada by Duraflor/Canplas

Dia.	Tail	Color	Note	Description	Flapper	Each #	Qty	Case #	Package	UPC
4"	flush	white		Reversible, adjusts from 0 to ½"	weighted	11714	12	111714	Bulk	•
4"	flush	brown		Reversible, adjusts from 0 to ½"	weighted	11715	12	111715	Bulk	•
4"	flush	white		Reversible, adjusts from ½" to 1.15"	weighted	11716	12	111716	Bulk	•
4"	flush	brown		Reversible, adjusts from ½" to 1.15"	weighted	11717	12	111717	Bulk	•
4"	11"	white	unassembled	Reversible, adjusts from 0 to ½"	weighted	11705	12	111705	Bulk	
4"	11"	brown	unassembled	Reversible, adjusts from 0 to ½"	weighted	11712	12	111712	Bulk	
4"	11"	white	unassembled	Reversible, adjusts from ½" to 1.15"	weighted	11706	12	111706	Bulk	
4"	11"	brown	unassembled	Reversible, adjusts from ½" to 1.15"	weighted	11713	12	111713	Bulk	
4"	11"	silver	Tailpipe	Aluminum tailpipe ships flat, 3 tabs		12421	24	112421	Bulk	

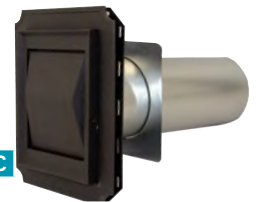

34 Accessories

Foil Tape - Model 2158A

- Used to seal connections between Class 0 & Class 1 ducts and air connectors
- UL® Listed 82P4; 181A-P and 181B-FX • Meets HUD & Boca Codes



Description	Each #	Qty	Case #	Package
2.5" wide by 60 yard roll	11704	16	111704	Display Label

Steel Screw Clamps

- 4" Minimum I.D. 3.90", Max 4¼" (1.5" screw) or Max 4.4" (2" screw)
- Galvanized material designed to resist stretching

Dia.	Screw Length	Model	Note	Each #	Qty	Case #	Package
3"	1.5"	SSC1.5		10065	100	110065	Bulk
4"	1.5"	SSC1.5	2 clamps per card	10074	25	110074	Display Card
4"	1.5"	SSC1.5		10071	100	110071	Bulk
6"	1.5"	SSC1.5		11417	40	111417	Bulk
4"	2"	SSC2.0		10075	100	110075	Bulk



Zip Torq™ Clamps

- Unique polymeric stretch plastic
- Tightens without tools
- Loosens with #2 phillips screwdriver

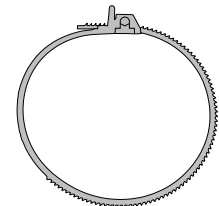

Dia.	Each #	Qty	Case #	Package
3" - 4"	12145	100	112145	Bulk

Worm Gear Clamps

- Galvanized
- Plated steel band, housing and screw • Imported

Dia.	Note	Each #	Qty	Case #	Package
3"		11908	100	111908	Bulk
4"		11909	100	111909	Bulk
4"	2 clamps per card	11546	25	111546	Display Card
6"		11911	40	111911	Bulk

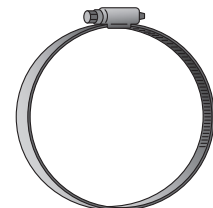

Steel Tension Clamps

- "Spring" clamps
- No tools required • Imported

Dia.	Note	Each #	Qty	Case #	Package
3"		10480	100	110480	Bulk
4"	2 clamps per card	11551	25	111551	Display Card
4"		10482	100	110482	Bulk

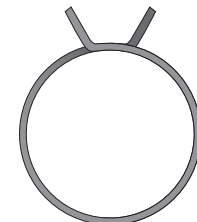

Plastic Cable Tie Clamps

- Releasable Cable Tie
- Press tab, release and reuse • Imported

Dia.	Note	Each #	Qty	Case #	Package
3" - 4"	2 clamps per card	11423	25	111423	Display Card

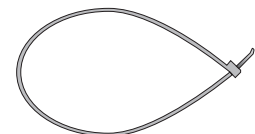

Draft Stopper

- Helps prevent cold air from entering home through clothes dryer by inserting between clothes dryer duct and wall pipe.

Dia.	Each #	Qty	Case #	Package
4"	11577	6	111577	Bulk



Dryer Heat Diverter

* Manual control directs heat into home in cold weather or outside in warm weather.



Dia.	Each #	Qty	Case #	Package
4"	11575	6	111575	Bulk

Window Plate

• 12" high by 18" wide Aluminum

Dia.	Each #	Qty	Case #	Package
3"	10494	25	110494	Bulk
4"	10495	25	110495	Bulk

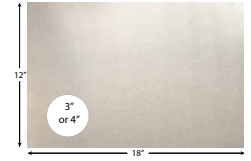

Aluminum Trim Plate

* For aluminum hoods AWM3xx, ASM3xx, plastic hoods PWM6xx, PML3XX, PML3XX

Dia.	Overall size	Overall size	Hem	Each #	Qty	Case #	Package
3"	5.625" x 5.625"	curved edge	hem inside cutout	10126	100	110126	Bulk
4"	5.625" x 5.625"	curved edge	hem inside cutout	10122	100	110122	Bulk
4"	6" x 6" with mounting holes	square edge	no hem	10912	100	110912	Bulk



PN 10122

P-Tanium™ Trim Plates

* For galvanized hoods GWM4XX

Dia.	Each #	Qty	Case #	Package
3"	10056	100	110056	Bulk
4"	10057	100	110057	Bulk



Adapters (for RV28, RVL28, & SV28 Eave)

- Snap fits with RV28 Gooseneck Roof Cap, RVL28 Low Profile Roof Cap & SV28 Eave Vent
- Made in Canada by Primex

Dia.	Color	Each #	Qty	Case #	Package
4"	black	RV28-4	30	1RV28-4	Bulk
6"	black	RV28-6	25	1RV28-6	Bulk
7"	black	RV28-7	25	1RV28-7	Bulk
8"	black	RV28-8	18	1RV28-8	Bulk



1

Visit our website:
<https://buildersbest.com>
for detailed product information

2

Resource Page =
Spec Sheets
Instructions

3

Product Page =
Categories

4

SEARCH
enter part
numbers
names
or types

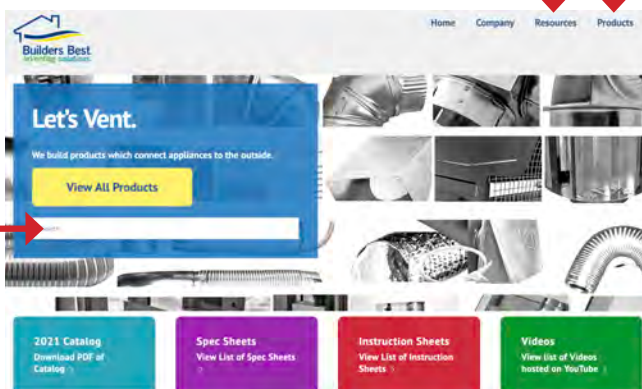

5

Quick
Link
Buttons

6

Alternate
Part
Images

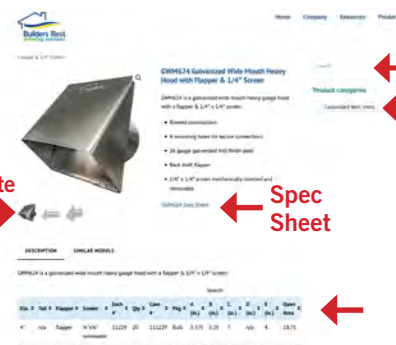

4

SEARCH
Drop Down
Categories

7

Part number
table
displays
diameters
and package
types

Builder's Best, Inc.
201 Broiles
Jacksonville TX 75766

Email:
sales@buildersbest.com for inquiries

orders@buildersbest.com for orders

Phone:
903-586-8283

Website:
BuildersBest.com

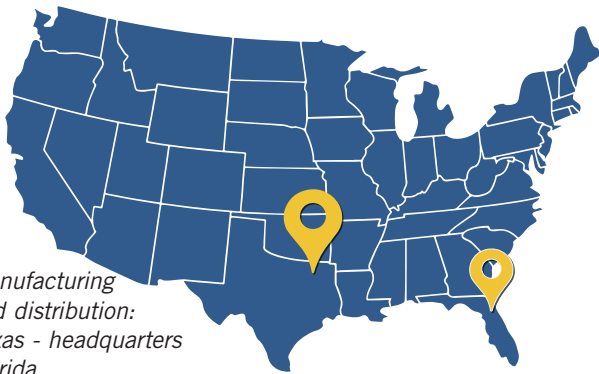

Manufacturing
and distribution:
Texas - headquarters
Florida

Trademarks:

The All Metal Solution to Dryer Venting™ inVenting solutions™
E-Z-Fasten™ Readi-Pipe™ Econo-Pipe™ Pro-Vent™ ClearDuct™
Snap-Lock™ Zero Periscope™ Umbrella Cap™ Broad Band™
P-Tanium™ ZipTorq™ and A-Seam™
are trademarks of Builder's Best, Inc.

Builder's Best® Over-The-Top®
SAF-T-DUCT® Thermofin® T-Fin®
METALFLEX® Nemco® Close Elbow® Offset Elbow®
and the Builder's Best Logo
are registered trademarks of Builder's Best, Inc.

The above products are Made in the USA of globally sourced components.

We are authorized distributors for
PrimexVents by Menzies and Durafluo by Canplas/Ipex, both made in Canada.

Builder's Best, Inc.

U.S. Patents:

5,121,948; 5,133,579; 5,145,217; 5,158,328; 5,498,204; 5,653,631;
5,819,435; 5,943,743; 6,035,495; 6,370,794; 6,390,510; 7,431,163B2;
20050269243A1; 9,377,141B2; 10,125,899B2; 11,402,039; D.335,174;
D.342,130; D.342,782

Canadian patents:

2,062,123; 2,063,098; 2,201,956;
2,279,599; 2,299,989; 2,317,863; 2,630,761C; 2,508,954C; 2,857,172C;
2,916,774A1;

and/or patents pending

Associations:



Social:



Builder's Best is committed to manufacturing in America and distributing quality venting solutions. Products are Made in the USA of US and foreign components unless expressly noted.

Established in 1990, we make quicker and safer ways of venting appliances. As a result, professional installers have relied on our solutions for nearly 30 years.

We design, engineer, tool, manufacture, print and package in-house. We ship truckloads nationwide.

Our products are carried by wholesalers, distributors and retailers coast to coast.

